

SNA5000A Series Vector Network Analyzer

Programming Guide

PG09050_E01A



SIGLENT TECHNOLOGIES CO.,LTD

Copyright

- ◆ **SIGLENT TECHNOLOGIES CO., LTD** All Rights Reserved.
- ◆ **SIGLENT** is the registered trademark of **SIGLENT TECHNOLOGIES CO., LTD**.
- ◆ Information in this publication replaces all previously corresponding material.
- ◆ **SIGLENT** reserves the right to modify or change parts of or all the specifications or pricing policies at company's sole decision.
- ◆ Any method of copying, extracting or translating the contents of this manual is not allowed without the permission of **SIGLENT**.

Contents

1.	Programming Overview	3
1.1	Remotely Operating the Analyzer	3
1.2	Build Communication	4
1.3	Remote Control Capabilities.....	6
2.	SCPI Overview	11
2.1	Command Format	11
2.2	Symbol Instruction.....	11
2.3	Parameter Type.....	12
2.4	Command Abbreviation	13
3.	System Commands	14
3.1	IEEE Common Commands	14
3.2	Calculate Subsystem.....	17
3.3	Display Subsystem.....	75
3.4	Sense Subsystem	83
3.5	Trigger Subsystem	123
3.6	Initiate Subsystem	128
3.7	Output Subsystem.....	129
3.8	Memory Subsystem.....	130
3.9	Service Subsystem.....	137
3.10	Source Subsystem	140
3.11	System Subsystem.....	146
4.	TDR Commands.....	154
4.1	Calculate Subsystem.....	154
4.2	Display Subsystem.....	176
4.3	Memory Subsystem.....	181
4.4	Sense Subsystem	182
4.5	Trigger Subsystem	187
4.6	System Subsystem.....	188
5.	Programming Examples	189
5.1	Examples of Using VISA	189
5.2	Examples of Using Sockets/Telnet	200

1. Programming Overview

SNA5000A - Vector Network Analyzer, support LAN, USB Device, and GPIB-USB Host interfaces. By using these interfaces, in combination with programming languages and/or NI-VISA software, users can remotely control the analyzer based on SCPI (Standard Commands for Programmable Instruments) command set, and interoperate with other programmable instruments.

This chapter introduces how to build communication between the spectrum analyzer and a controller computer with these interfaces.

1.1 Remotely Operating the Analyzer

The analyzer provides both the USB and LAN connection which allows you to set up a remote operation environment with a controller computer. A controller computer could be a personal computer (PC) or a minicomputer. Some intelligent instruments also function as controllers.

1.1.1 Connecting the Analyzer via the USB Device port

Refer to the following steps to finish the connection via USB-Device:

1. Install NI-VISA on your PC for USB-TMC driver.
2. Connect the analyzer USB Device port to a PC with a USB A-B cable.



3. Switch on the analyzer.

The analyzer will be detected automatically as a new USB hardware.

1.1.2 Connecting the Analyzer via the LAN port

Refer to the following steps to finish the connection via LAN:

1. Install NI-VISA on your PC for VXI driver. Or without NI-VISA, using socket or telnet in your PC's Operating System.
2. Connect the analyzer to PC or the local area network with a LAN cable



3. Switch on the analyzer.

4. Press button on the front panel **System** →LAN Status to enter the LAN Config
5. Select the IP Config between Static and DHCP
 - ◆ DHCP: the DHCP server in the current network will assign the network parameters automatically (IP address, subnet mask, gate way) for the analyzer.
 - ◆ Static: you can set the IP address, subnet mask, gate way manually. Press Apply.

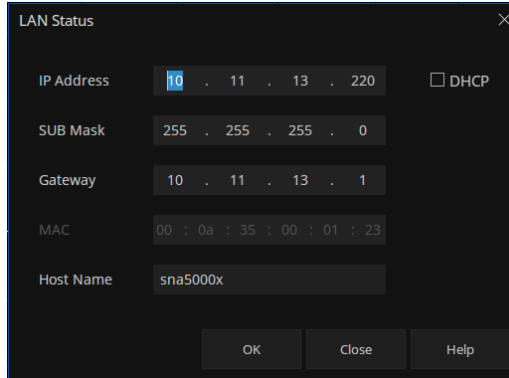

The analyzer will be detected automatically or manually as a new LAN point.

1.1.3 Connecting the Analyzer via the USB-Host port (With USB-GPIB Adaptor)

Refer to the following steps to finish the connection via USB.

1. Install NI-VISA on your PC for GPIB driver.
2. Connect the analyzer USB Host port to a PC's GPIB card port, with SIGLENT USB-GPIB adaptor.



3. Switch on the analyzer
4. Press button on the front panel **System** →GPIB to enter the GPIB number.

The analyzer will be detected automatically as a new GPIB point.

1.2 Build Communication

1.2.1 Build Communication Using VISA

NI-VISA includes a Run-Time Engine version and a Full version. The Run-Time Engine version provides NI device drivers such as USB-TMC, VXI, GPIB, etc. The full version includes the Run-Time Engine and a software tool named NI MAX that provides a user interface to control the device.

You can get NI-VISA full version from:

<http://www.ni.com/download/>.

After download you can follow the steps below to install it:

- a. Double click the visa_full.exe, dialog shown as below:
- b. Click Unzip, the installation process will automatically launch after unzipping files. If you

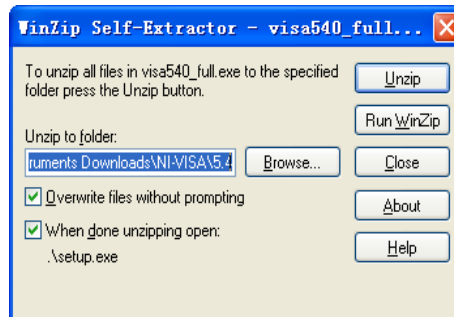

r computer needs to install .NET Framework 4, its setup process will auto start.

- c. The NI-VISA installing dialog is shown above. Click Next to start the installation process. Set the install path, default path is “C:\Program Files\National Instruments\”, you can chan

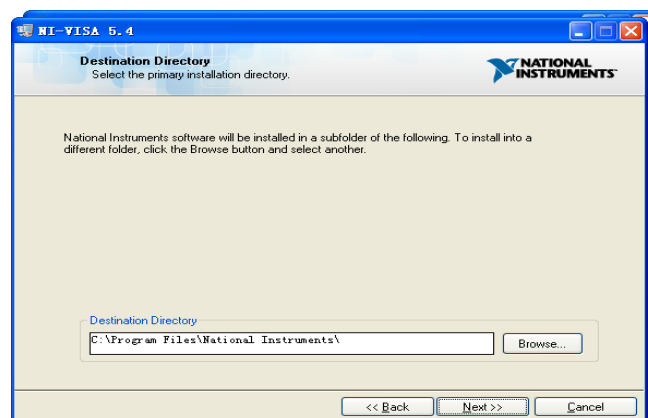

ge it. Click Next, dialog shown as above.

- d. Click Next twice, in the License Agreement dialog, select the "I accept the above 2 License Agreement(s).", and click Next, dialog shown as below:

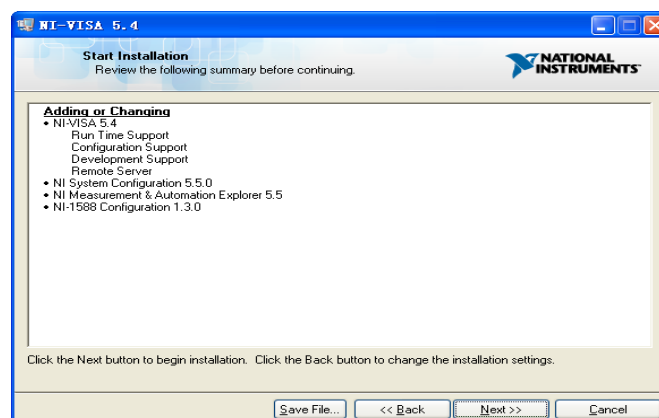

- e. Click Next to run installation.

Now the installation is complete, reboot your PC.

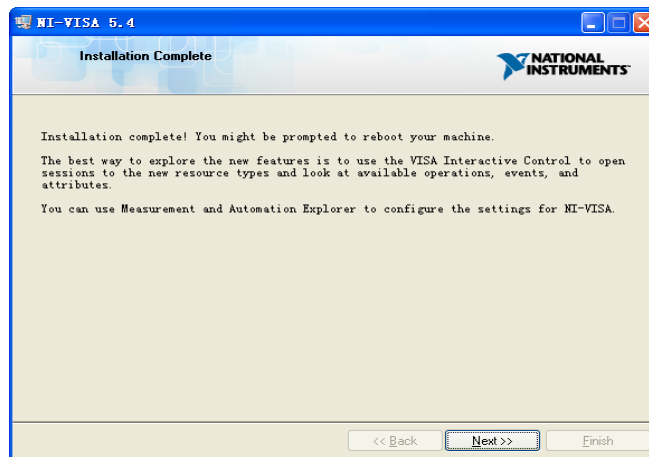

1.2.2 Build Communication Using Sockets/Telnet

Through LAN interface, VXI-11, Sockets and Telnet protocols can be used to communicate with the spectrum analyzer. VXI-11 is provided in NI-VISA, while Sockets and Telnet are commonly included in PC's OS initially.

Sockets LAN is a method used to communicate with the vector network analyzer over the LAN interface using the Transmission Control Protocol/Internet Protocol (TCP/IP). A socket is a fundamental technology used for computer networking and allows applications to communicate using standard mechanisms built into network hardware and operating systems. The method accesses a port on the spectrum analyzer from which bidirectional communication with a network computer can be established.

Before you can use sockets LAN, you must select the analyzer's sockets port number to use:

- ◆ Standard mode. Available on port 5025. Use this port for programming.
- ◆ Telnet mode. The telnet SCPI service is available on port 5024.

1.3 Remote Control Capabilities

1.3.1 User-defined Programming

Users can use SCPI commands to program and control the vector network analyzer. For details, refer to the introductions in "Programming Examples".

1.3.2 Send SCPI Commands via NI MAX

Users can control the vector network analyzer remotely by sending SCPI commands via NI-MAX software.

1.3.2.1 Using USB

Run NI MAX software.

- 1, Click “Device and interface” at the upper left corner of the software.
- 2, Find the “USBTMC” device symbol.



- 3, Click “Open VISA Test Panel” option button, then the following interface will appear.
- 4, Click the “Input/Output” option button and click the “Query” option button in order to view the operation information.

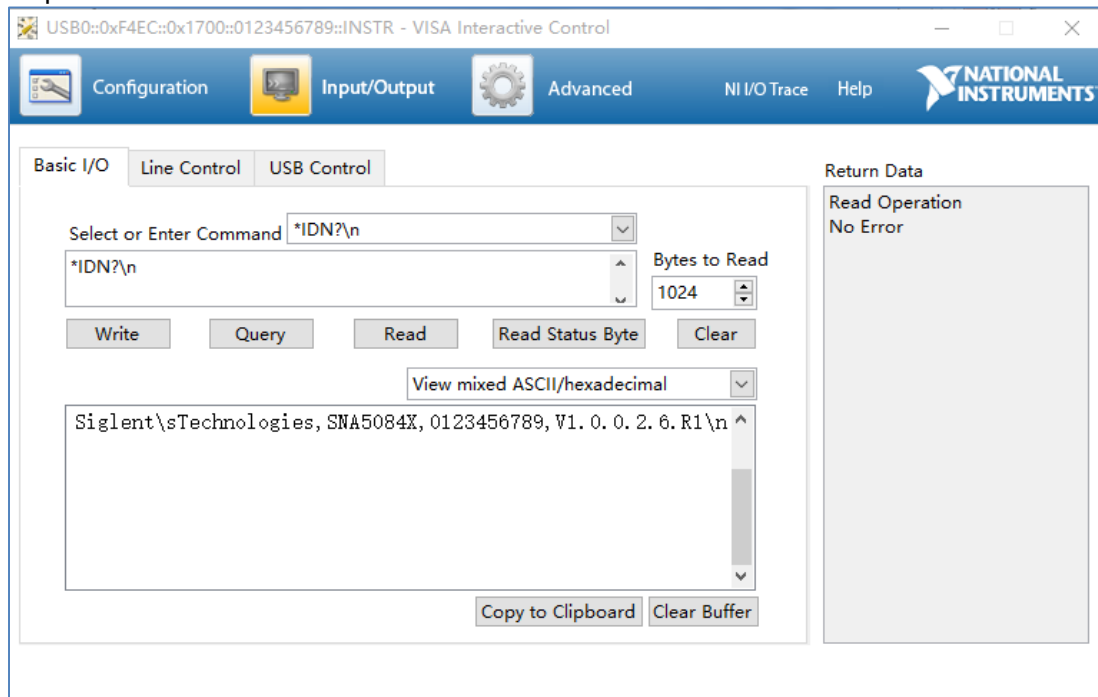

NOTE: The “*IDN?” command (known as the Identification Query) returns the instrument manufacturer, instrument model, serial number, and other identification information.

1.3.2.2 Using LAN

Select, “Add Network Device”, and select “VISA TCP/IP Resource” as shown:

Run NI MAX software.

1. Click “Device and interface” at the upper left corner of the software.
2. Find the “Network Devices” symbol; click “Add Network Devices”.

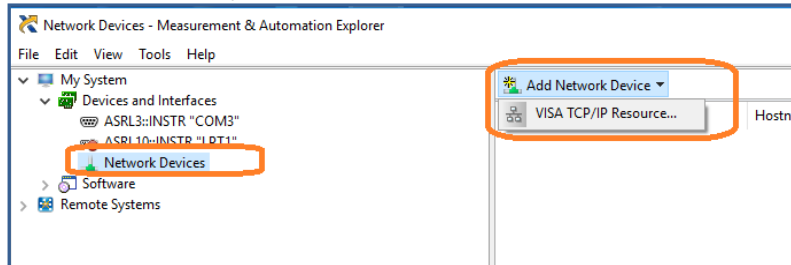

3. Select “Manual Entry of LAN instrument”, select “Next”, and enter the IP address as shown. Click Finish to establish the connection:

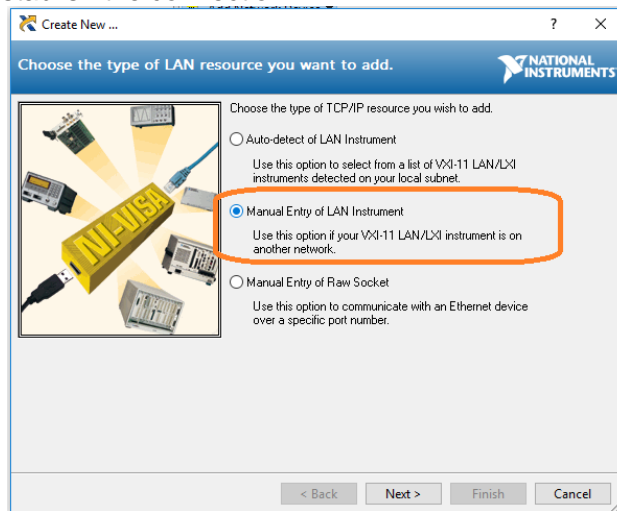

NOTE: Leave the LAN Device Name BLANK or the connection will fail.

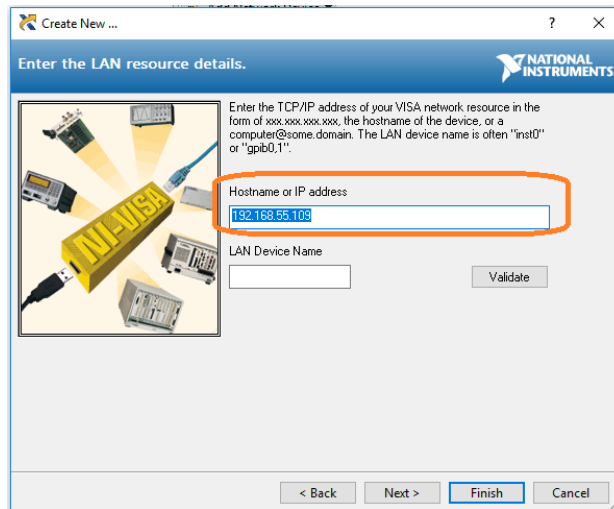

4. After a brief scan, the connection should be shown under “Network Devices”:

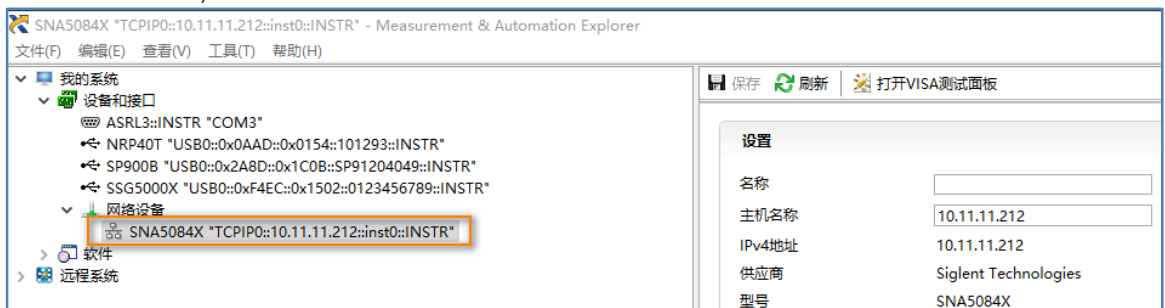

5. Right-click on the product and select “Open NI-VISA TestPanel”:

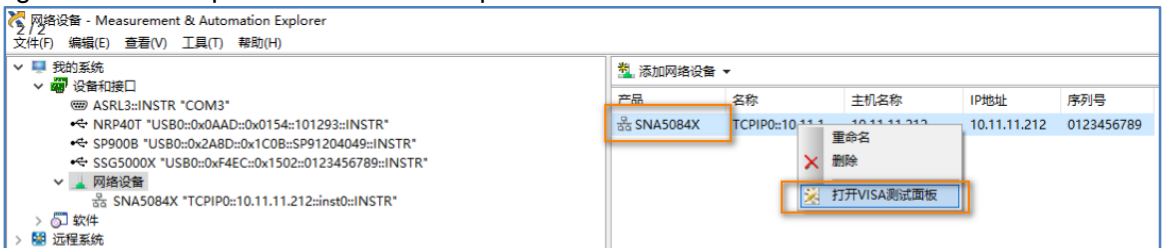

6. Click “Input/Output” option button and click “Query” option button. If everything is OK, you will see the Read operation information returned as shown below.

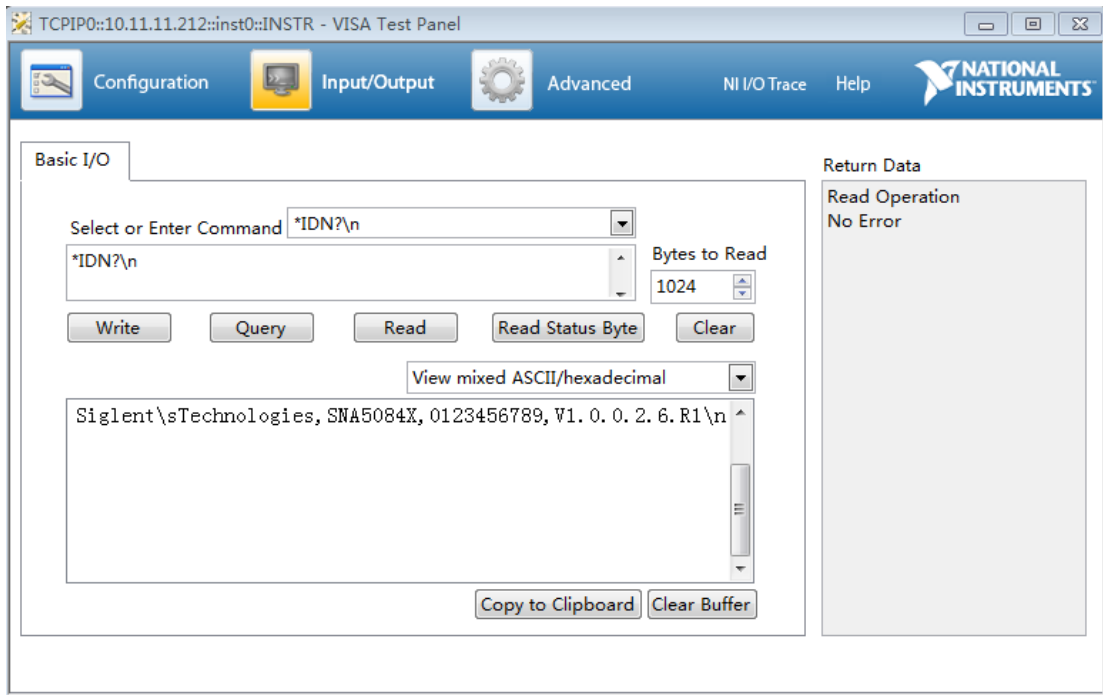

2. SCPI Overview

2.1 Command Format

SCPI commands present a hierarchical tree structure containing multiple subsystems, and each of the subsystems is made up of a root keyword and several subkeywords. The command string usually starts with “:”, the keywords are separated by “.” and the followed parameter settings are separated by space. Query commands add “?” at the end of the string.

For example:

```
:SENSe:FREQuency:CENTer <freq>
```

```
:SENSe:FREQuency:CENTer?
```

SENSe is the root key of the command, FREQuency and CENTer are second and third keywords. The command begins with “:”, and separates the keywords at the same time, and the <freq> separated by space and represents the parameter available for setting; “?” represents a query.

2.2 Symbol Instruction

The following four symbols are not the content of SCPI commands and cannot be sent with the commands, but are usually used in the commands.

1, Triangle Brackets < >

The parameter in the triangle brackets must be replaced by an effective value. For example,

Send the “:SENSe1:SWEEp:POINts <value>” command in “:SENSe1:SWEEp:POINts 201”.

2, Square Brackets []

The content in the square brackets can be ignored. When the parameter is ignored, the instrument will set the parameter to its default. For example,

In the “:SENSe:CORRection:IMPedance[:INPut][:MAGNitude]?” command, sending any of the four commands below can generate the same effect:

```
:SENSe:CORRection:IMPedance?
```

```
:SENSe:CORRection:IMPedance:INPut?
```

```
:SENSe:CORRection:IMPedance:MAGNitude?
```

```
:SENSe:CORRection:IMPedance:INPut:MAGNitude?
```

3, Vertical Bar |

The vertical bar is used to separate multiple parameters and when sending the command, you can choose one of the parameters. For example, In the “:DISPlay:MAXimize ON|OFF|1|0” command, the parameters available are “OFF”, “ON”, “0” or “1”.

4, Braces { }

The parameters in the braces are optional which can be ignored or set for one or more times. For example:

“:SENSe{[1]-200}:SEGMENT:LIST:CONTROL:DATA <Boolean>{,<Boolean>}” in the command, the {,<Boolean>} parameters can be ignored or set for one or more times.

2.3 Parameter Type

The parameters in the commands introduced in this manual include 6 types: Boolean, enumeration, integer, float, discrete and string.

1, Boolean

The parameters in the commands could be “OFF”, “ON”, “0” or “1”. For example,:

CALCulate#:TRACe#:SMOothing[:STATe] ON|OFF|1|0

2, Enumeration

The parameter could be any of the values listed. For example:

:SENSe#:SWEep:TYPE LINear|LOGarithmic|POWER|CW|SEGMENT

The parameter should be “LINear”, “LOGarithmic”, “POWER”, “CW” or “SEGMENT”.

3, String

The parameter should be the combinations of ASCII characters. For example:

:SYSTem:COMMunicate:LAN:IPADdress <“xxx.xxx.xxx.xxx”>

The parameter can be set as “192.168.1.12” string.

4, Integer

Except other notes, the parameter can be any integer within the effective value range. For example:

:SYSTem:COMMunicate:GPIB:ADDRess <value>

The parameter <value> can be set to any integer between 1 and 30.

5, Float

The parameter could be any value within the effective value range according to the accuracy requirement (the default accuracy contains up to 9 digits after the decimal points). For example:

:SENSe#:FREQUency:STARt <value>

The parameter <value > can be set to any real number between 9k and 8.5G.

6, Discrete

The parameter could only be one of the specified values and these values are discontinuous. For example:

:SENSe#:BANDwidth[:RESolution] <numeric>

The parameter <numeric> could only be one of 10, 15, 20, 30, 40, 50, 70, 100 ... 7k, 10k ...1M, 1.5M, 3M.

2.4 Command Abbreviation

All of the commands are not case sensitive, so you can use any of them. But if abbreviation is used, all the capital letters in the command must be written completely. For example:

:CALCulate1:TRACe1:BLIMit:MINimum?

Can be abbreviated to:

:CALC1:TRAC1:BLIM:MIN?

3. System Commands

3.1 IEEE Common Commands

3.1.1 Identification Query (*IDN)

Command Format	*IDN?
Instruction	Returns an instrument identification information string. The string will contain the manufacturer, model number, serial number, and software number.
Menu	None
Example	*IDN? Return: Siglent Technologies,SNA5084X,1234567890,V1.0.0.1.5

3.1.2 Reset (*RST)

Command Format	*RST
Instruction	This command presets the instrument to a factory defined condition that is appropriate for remote programming operation. *RST is equivalent to performing the two commands :SYSTem:PRESet and *CLS. This command always performs a factory preset.
Menu	None
Example	*RST

3.1.3 Clear Status (*CLS)

Command Format	*CLS
Instruction	Clears the status byte register. It does this by emptying the error queue and clearing all bits in all of the event registers. The status byte register summarizes the states of the other registers. It is also responsible for generating service requests.
Menu	None
Example	*CLS

3.1.4 Standard Event Status Enable (*ESE)

Command Format	*ESE <numeric> *ESE?
Instruction	Set the bits in the Standard Event Status Enable Register. This register monitors I/O errors and synchronization conditions such as operation complete, request control, query error, device dependent error, execution error, command error and power on. A summary bit is generated on execution of the command. The query returns the state of the Standard Event Status Enable Register.
Menu	None
Example	*ESE 16 *ESE? Return: 16

3.1.5 Standard Event Status Register Query (*ESR)

Command Format	*ESR?
Instruction	This command reads the value of the Standard Event Status Register. Execution of this command clears the register value.
Menu	None
Example	*ESR?

3.1.6 Operation Complete Query (*OPC)

Command Format	*OPC *OPC?
Instruction	Set bit 0 in the Standard Event Status Register to “1” when all pending operations have finished. The query stops any new commands from being processed until the current processing is complete. Then it returns a “1”, and the program continues. This query can be used to synchronize events of other instruments on the external bus. Returns a “1” if the last processing is complete. Use this query when there’s a need to monitor the command execution status, such as a sweep execution.
Menu	None
Example	*OPC?

3.1.7 Service Request Enable (*SRE)

Command Format	*SRE <integer> *SRE?
Instruction	This command enables the desired bits of the Service Request Enable Register. The query returns the value of the register, indicating which bits are currently enabled. The default value is 0.
Menu	None
Example	*SRE 1 *SRE?

3.1.8 Status Byte Query (*STB)

Command Format	*STB?
Instruction	This command reads the value of Status Byte Register.
Menu	None
Example	*STB?

3.1.9 Wait-to-Continue (*WAI)

Command Format	*WAI
Instruction	This command causes the instrument to wait until all pending commands are completed before executing any additional commands. There is no query form to the command.
Menu	None
Example	*WAI

3.1.10 Trigger a sweep (*TRG)

Command Format	*TRG
Instruction	This command triggers the SNA if the trigger source is set to BUS.
Menu	None
Example	*TRG

3.2 Calculate Subsystem

3.2.1 Measurement Type (:CALCulate{[1]-200}:PARAMeter{[1]-200}:DEFine)

Command Format	:CALCulate{[1]-200}:PARAMeter{[1]-200}:DEFine { S11 S21 S31 S41 S12 S22 S32 S42 S13 S23 S33 S43 S14 S24 S34 S44 A B C D R1 R2 R3 R4} :CALCulate{[1]-200}:PARAMeter{[1]-200}:DEFine?
Instruction	This command sets and gets the measurement parameter of the selected trace, for the selected channel.
Parameter Type	String
Parameter Range	Select either one of the following: <ul style="list-style-type: none"> ● "S<XY>" Where: x=1to 4 Y=1to 4 ● A B C D ● R<X> (X=1-4) ● AUX1 or AUX2
Return	String
Default	S11
Menu	Measure
Example	:CALCulate1:PARAMeter1:DEFine S12 :CALCulate1:PARAMeter1:DEFine? Return: S12

3.2.2 Balance Measurement Topology (:CALCulate{[1]-200}:DTOPology)

Command Format	:CALCulate{[1]-200}:DTOPology <TopologyType>,<PortTopologyList> :CALCulate{[1]-200}:DTOPology?
Instruction	This command sets and gets the device type for the balanced measurement.
Parameter Type	String
Parameter Range	Topology Type: B: Balance (2 Ports) SB: Single – Balance (3 Ports) SSB: Single – Single – Balance (4 Ports) BB: Balance – Balance (4 Ports) Port Topology List: Integers represent the ports as the port numbers, expressing the ports in the device topology in order.
Return	String
Default	B,1,2
Menu	Measure > Balanced > Topology...
Example	:CALCulate1:DTOPology SB,1,2,3 :CALCulate1:DTOPology? Return: SB,1,2,3

3.2.3 Select Trace (:CALCulate{[1]-200}:PARAMeter{[1]-200}:SElect)

Command Format	:CALCulate{[1]-200}:PARAmeter{[1]-200}:SELEct
Instruction	This command sets the selected trace of the selected channel to the active trace.
Parameter Type	None
Parameter Range	None
Return	None
Default	None
Menu	Display > Trace Setup > Select
Example	:CALCulate1:PARAmeter2:SELEct

3.2.4 Bandwidth Test State (:CALCulate{[1]-200}[:SELEcted]:BLIMit[:STATe])

Command Format	:CALCulate{[1]-200}[:SELEcted]:BLIMit[:STATe] {ON OFF 1 0} :CALCulate{[1]-200}[:SELEcted]:BLIMit[:STATe]? :CALCulate{[1]-200}:TRACe{[1]-200}:BLIMit[:STATe] :CALCulate{[1]-200}:TRACe{[1]-200}:BLIMit[:STATe]?
Instruction	<ol style="list-style-type: none"> 1. This command turns ON/OFF the bandwidth test function, for the active trace of selected channel. 2. This command turns ON/OFF the bandwidth test function of the selected trace for the selected channel.
Parameter Type	Boolean
Parameter Range	ON OFF 1 0
Return	Boolean
Default	OFF
Menu	Math > Analysis > Limit > Bandwidth
Example	<pre>:CALCulate1:BLIMit ON :CALCulate1:BLIMit? Return: 1 :CALCulate1:TRACe1:BLIMit OFF :CALCulate1:TRACe1:BLIMit? Return: 0</pre>

3.2.5 Bandwidth Test Marker State (:CALCulate{[1]-200}[:SELEcted]:BLIMit:DISPlay:MARKer)

Command Format	:CALCulate{[1]-200}[:SELEcted]:BLIMit:DISPlay:MARKer {ON OFF 1 0} :CALCulate{[1]-200}[:SELEcted]:BLIMit:DISPlay:MARKer? :CALCulate{[1]-200}:TRACe{[1]-200}:BLIMit:DISPlay:MARKer {ON OFF 1 0} :CALCulate{[1]-200}:TRACe{[1]-200}:BLIMit:DISPlay:MARKer?
Instruction	<ol style="list-style-type: none"> 1. This command turns ON/OFF the marker display of the bandwidth test, for the active trace of selected channel. 2. This command turns ON/OFF the marker display of the bandwidth test of selected trace for the selected channel.
Parameter Type	Boolean
Parameter Range	ON OFF 1 0

Return	Boolean
Default	OFF
Menu	Math > Analysis > Limit > Bandwidth > Bandwidth Marker On
Example	:CALCulate1:BLIMit:DISPlay:MARKer ON :CALCulate1:BLIMit:DISPlay:MARKer? Return: 1 :CALCulate1:TRACe1:BLIMit:DISPlay:MARKer OFF :CALCulate1:TRACe1:BLIMit:DISPlay:MARKer? Return: 0

3.2.6 Bandwidth Test Value State (:CALCulate{[1]-200}[:SElected]:BLIMit:DISPlay:VALue)

Command Format	:CALCulate{[1]-200}[:SElected]:BLIMit:DISPlay:VALue {ON OFF 1 0} :CALCulate{[1]-200}[:SElected]:BLIMit:DISPlay:VALue? :CALCulate{[1]-200}:TRACe{[1]-200}:BLIMit:DISPlay:VALue {ON OFF 1 0} :CALCulate{[1]-200}:TRACe{[1]-200}:BLIMit:DISPlay:VALue?
Instruction	1. This command turns ON/OFF the bandwidth value display of the bandwidth test, for the active trace of selected channel. 2. This command turns ON/OFF the bandwidth value display of the bandwidth test of selected trace for the selected channel.
Parameter Type	Boolean
Parameter Range	ON OFF 1 0
Return	Boolean
Default	OFF
Menu	None
Example	:CALCulate1:BLIMit:DISPlay:VALue ON :CALCulate1:BLIMit:DISPlay:VALue? Return: 1 :CALCulate1:TRACe1:BLIMit:DISPlay:VALue OFF :CALCulate1:TRACe1:BLIMit:DISPlay:VALue? Return: 0

3.2.7 Get Bandwidth Test Fail Result (:CALCulate{[1]-200}[:SElected]:BLIMit:FAIL?)

Command Format	:CALCulate{[1]-200}[:SElected]:BLIMit:FAIL? :CALCulate{[1]-200}:TRACe{[1]-200}:BLIMit:FAIL?
Instruction	1. This command gets the bandwidth limit test results, for the active trace of selected channel. 2. This command gets the bandwidth limit test results, for the selected trace of selected channel.
Parameter Type	None
Parameter Range	None
Return	1 0 1: Pass 0: Fail
Default	None
Menu	None

Example	:CALCulate1:BLIMit:FAIL? :CALCulate1:TRACe1:BLIMit:FAIL?
---------	---

3.2.8 Bandwidth Test Threshold (:CALCulate{[1]-200}[:SElected]:BLIMit:DB)

Command Format	:CALCulate{[1]-200}[:SElected]:BLIMit:DB <numeric> :CALCulate{[1]-200}[:SElected]:BLIMit:DB? :CALCulate{[1]-200}:TRACe{[1]-200}:BLIMit:DB <numeric> :CALCulate{[1]-200}:TRACe{[1]-200}:BLIMit:DB?
Instruction	1. This command sets/gets the bandwidth threshold value (attenuation from the peak) of the bandwidth test, for the selected channel. 2. This command sets/gets the bandwidth threshold value (attenuation from the peak) of the bandwidth test of selected trace for the selected channel.
Parameter Type	Float, unit: dB
Parameter Range	0-500MdB
Return	Float, unit: dB
Default	3
Menu	Math > Analysis > Limit > Bandwidth > N dB Points
Example	:CALCulate1:BLIMit:DB 3.5 :CALCulate1:BLIMit:DB? Return: 3.5 :CALCulate1:TRACe1:BLIMit:DB 4 :CALCulate1:TRACe1:BLIMit:DB? Return: 4

3.2.9 Bandwidth Test Maximum (:CALCulate{[1]-200}[:SElected]:BLIMit:MAXimum)

Command Format	:CALCulate{[1]-200}[:SElected]:BLIMit:MAXimum <numeric> :CALCulate{[1]-200}[:SElected]:BLIMit:MAXimum? :CALCulate{[1]-200}:TRACe{[1]-200}:BLIMit:MAXimum <numeric> :CALCulate{[1]-200}:TRACe{[1]-200}:BLIMit:MAXimum?
Instruction	1. This command sets/gets the upper limit value of the bandwidth test, for the selected channel. 2. This command sets/gets the upper limit value of the bandwidth test of selected trace for the selected channel.
Parameter Type	Float
Parameter Range	None
Return	Float
Default	300kHz
Menu	Math > Analysis > Limit > Bandwidth > Max Bandwidth
Example	:CALCulate1:BLIMit:MAXimum 3500000 :CALCulate1:BLIMit:MAXimum? Return: 3500000 :CALCulate1:TRACe1:BLIMit:MAXimum 4000000 :CALCulate1:TRACe1:BLIMit:MAXimum? Return: 4000000

3.2.10 Bandwidth Test MiNimum (:CALCulate{[1]-200}[:SELEcted]:BLIMit:MiNimum)

Command Format	:CALCulate{[1]-200}[:SELEcted]:BLIMit:MiNimum <numeric> :CALCulate{[1]-200}[:SELEcted]:BLIMit:MiNimum? :CALCulate{[1]-200}:TRACe{[1]-200}:BLIMit:MiNimum <numeric> :CALCulate{[1]-200}:TRACe{[1]-200}:BLIMit:MiNimum?
Instruction	1. This command sets/gets the lower limit value of the bandwidth test, for the selected channel. 2. This command sets/gets the lower limit value of the bandwidth test of selected trace for the selected channel.
Parameter Type	Float
Parameter Range	None
Return	Float
Default	10kHz
Menu	Math > Analysis > Limit > Bandwidth > Min Bandwidth
Example	:CALCulate1:BLIMit:MiNimum 2000000 :CALCulate1:BLIMit:MiNimum? Return: 2000000 :CALCulate1:TRACe1:BLIMit:MiNimum 5000000 :CALCulate1:TRACe1:BLIMit:MiNimum? Return: 5000000

3.2.11 Bandwidth Test Report Data (:CALCulate{[1]-200}[:SELEcted]:BLIMit:REPort[:DATA]?)

Command Format	:CALCulate{[1]-200}[:SELEcted]:BLIMit:REPort[:DATA]? :CALCulate{[1]-200}:TRACe{[1]-200}:BLIMit:REPort[:DATA]?
Instruction	1. This command reads the bandwidth value of the bandwidth test, for the active trace of selected channel. 2. This command reads the bandwidth value of the bandwidth test of selected trace for the selected channel.
Parameter Type	None
Parameter Range	None
Return	Float
Default	None
Menu	None
Example	:CALCulate1:BLIMit:REPort? :CALCulate1:TRACe1:BLIMit:REPort?

3.2.12 Parameter Conversion State (:CALCulate{[1]-200}[:SELEcted]:CONVersion[:STATe])

Command Format	:CALCulate{[1]-200}[:SELEcted]:CONVersion[:STATe] {ON OFF 1 0} :CALCulate{[1]-200}[:SELEcted]:CONVersion[:STATe]? :CALCulate{[1]-200}:TRACe{[1]-200}:CONVersion[:STATe] {ON OFF 1 0} :CALCulate{[1]-200}:TRACe{[1]-200}:CONVersion[:STATe]?
Instruction	1. This command sets/gets the parameter conversion state for the active trace of selected channel. 2. This command sets/gets the parameter conversion state for the selected tra

	ce and selected channel.
Parameter Type	Boolean
Parameter Range	ON OFF 1 0
Return	Boolean
Default	OFF
Menu	Math > Analysis > Conversion
Example	:CALCulate1:CONVersion:STATe 1 :CALCulate1:CONVersion:STATe? Return: 1 :CALCulate1:TRACe1:CONVersion:STATe 1 :CALCulate1:TRACe1:CONVersion:STATe? Return: 1

3.2.13 Parameter Conversion (:CALCulate{[1]-200}[:SElected]:CONVersion:FUNcTion)

Command Format	:CALCulate{[1]-200}[:SElected]:CONVersion:FUNcTion {ZREFlection ZTRansmit YREFlection YTRansmit INVersion ZTSHunt YTSHunt CONJugation} :CALCulate{[1]-200}[:SElected]:CONVersion:FUNcTion? :CALCulate{[1]-200}:TRACe{[1]-200}:CONVersion:FUNcTion {ZREFlection ZTRansmit YREFlection YTRansmit INVersion ZTSHunt YTSHunt CONJugation} :CALCulate{[1]-200}:TRACe{[1]-200}:CONVersion:FUNcTion?
Instruction	1. This command sets/gets the parameter after conversion using the parameter conversion function, for the active trace of selected channel. 2. This command sets/gets the parameter after conversion using the parameter conversion function for the selected trace and selected channel.
Parameter Type	Enumeration
Parameter Range	ZREFlection ZTRansmit YREFlection YTRansmit INVersion ZTSHunt YTSHunt CONJugation
Return	Enumeration
Default	ZREFlection
Menu	Math > Analysis > Conversion
Example	:CALCulate1:CONVersion:STATe 1 :CALCulate1:CONVersion:FUNcTion ZTSHunt :CALCulate1:CONVersion:FUNcTion? Return: ZTSH :CALCulate1:TRACe1:CONVersion:STATe 1 :CALCulate1:TRACe1:CONVersion:FUNcTion YREFlection :CALCulate1:TRACe1:CONVersion:FUNcTion? Return: YREF

3.2.14 Formatted Data Array (:CALCulate{[1]-200}[:SElected]:DATA:FDATa)

Command Format	:CALCulate{[1]-200}[:SElected]:DATA:FDATa <numeric1>,... ,<numeric NOP*2> :CALCulate{[1]-200}[:SElected]:DATA:FDATa? :CALCulate{[1]-200}:TRACe{[1]-200}:DATA:FDATa <numeric1>,... ,<numeric NOP*2>
----------------	--

	:CALCulate{[1]-200}:TRACe{[1]-200}:DATA:FDATa?
Instruction	<ol style="list-style-type: none"> 1. This command sets/gets the formatted data array, for the active trace of selected channel. 2. This command sets/gets the formatted data array of selected trace for the selected channel.
Parameter Type	array
Parameter Range	<p>Indicates the array data (formatted data array) of NOP (number of measurement points)$\times 2$. Where n is an integer between 1 and NOP.</p> <p>Data(n$\times 2$-2) :Data (primary value) at the n-th measurement point.</p> <p>Data(n$\times 2$-1) :Data (secondary value) at the n-th measurement point. Always 0 when the data format is not the Smith chart format or the polar format.</p> <p>The index of the array starts from 0.</p>
Return	Array
Default	None
Menu	None
Example	<pre>:CALCulate1:DATA:FDATa a1,b1,.....,an,bn :CALCulate1:DATA:FDATa? :CALCulate1:TRACe1:DATA:FDATa a1,b1,.....,an,bn :CALCulate1:TRACe1:DATA:FDATa?</pre>

3.2.15 Corrected Data Array (:CALCulate{[1]-200}[:SElected]:DATA:SDATa)

Command Format	<pre>:CALCulate{[1]-200}[:SElected]:DATA:SDATa <numeric1>,... ,<numeric NOP*2> :CALCulate{[1]-200}[:SElected]:DATA:SDATa? :CALCulate{[1]-200}:TRACe{[1]-200}:DATA:SDATa <numeric1>,... ,<numeric NOP*2> :CALCulate{[1]-200}:TRACe{[1]-200}:DATA:SDATa?</pre>
Instruction	<ol style="list-style-type: none"> 1. This command sets/gets the corrected data array, for the active trace of selected channel. 2. This command sets/gets the corrected data array of selected trace for the selected channel.
Parameter Type	array
Parameter Range	<p>Indicates the array data (corrected data array) of NOP (number of measurement points)$\times 2$. Where n is an integer between 1 and NOP.</p> <p>Data(n$\times 2$-2) :Real part of the data (complex number) at the n-th measurement point.</p> <p>Data(n$\times 2$-1) :Imaginary part of the data (complex number) at the n-th measurement point.</p> <p>The index of the array starts from 0.</p>
Return	Array
Default	None
Menu	None
Example	<pre>:CALCulate1:DATA:SDATa a1,b1,.....,an,bn :CALCulate1:DATA:SDATa? :CALCulate1:TRACe1:DATA:SDATa a1,b1,.....,an,bn :CALCulate1:TRACe1:DATA:SDATa?</pre>

3.2.16 Electrical Delay Time (:CALCulate{[1]-200}[:SELe cted]:CORRection:EDELay:TIME)

Command Format	:CALCulate{[1]-200}[:SELe cted]:CORRection:EDELay:TIME <numeric> :CALCulate{[1]-200}[:SELe cted]:CORRection:EDELay:TIME? :CALCulate{[1]-200}:TRACe{[1]-200}:CORRection:EDELay:TIME <numeric> :CALCulate{[1]-200}:TRACe{[1]-200}:CORRection:EDELay:TIME?
Instruction	1. This command sets/gets the electrical delay time of the active trace of channels 1 to 200. 2. This command sets/gets the electrical delay time of selected trace for the selected channel.
Parameter Type	Float, unit s(second)
Parameter Range	-10~10
Return	Float, unit s(second)
Default	0
Menu	Scale > Electrical Delay > Delay Time
Example	:CALCulate1:CORRection:EDELay:TIME 1 :CALCulate1:CORRection:EDELay:TIME? Return: 1 :CALCulate1:TRACe1:CORRection:EDELay:TIME 2 :CALCulate1:TRACe1:CORRection:EDELay:TIME? Return: 2

3.2.17 Electrical Delay Distance (:CALCulate{[1]-200}:MEASure{[1]-200}:CORRection:EDELay:DISTance)

Command Format	:CALCulate{[1]-200}:MEASure{[1]-200}:CORRection:EDELay:DISTance <numeric> :CALCulate{[1]-200}:MEASure{[1]-200}:CORRection:EDELay:DISTance?
Instruction	This command sets/gets the electrical delay distance of selected trace for the selected channel.
Parameter Type	Float, unit meter, feet or inch
Parameter Range	None
Return	Float, unit meter, feet or inch
Default	0
Menu	Scale > Electrical Delay > Delay Distance
Example	:CALCulate1:MEASure1:CORRection:EDELay:DISTance 1 :CALCulate1:MEASure1:CORRection:EDELay:DISTance? Return: 1

3.2.18 Electrical Delay Distance Units (:CALCulate{[1]-200}:MEASure{[1]-200}:CORRection:EDELay:UNIT)

Command Format	:CALCulate{[1]-200}:MEASure{[1]-200}:CORRection:EDELay:UNIT {METer FEET INCH} :CALCulate{[1]-200}:MEASure{[1]-200}:CORRection:EDELay:UNIT?
Instruction	This command sets/gets the electrical delay distance units of selected trace for t

	he selected channel.
Parameter Type	enumeration
Parameter Range	METer FEET INCH
Return	METer FEET INCH
Default	METer
Menu	Scale > Electrical Delay > Distance Units
Example	:CALCulate1:MEASure1:CORRection:EDELay:UNIT FEET :CALCulate1:MEASure1:CORRection:EDELay:UNIT? Return: FEET

3.2.19 Phase Offset(:CALCulate{[1]-200}[:SElected]:CORRection:OFFSet:PHASe)

Command Format	:CALCulate{[1]-200}[:SElected]:CORRection:OFFSet:PHASe <numeric> :CALCulate{[1]-200}[:SElected]:CORRection:OFFSet:PHASe? :CALCulate{[1]-200}:TRACe{[1]-200}:CORRection:OFFSet:PHASe <numeric> :CALCulate{[1]-200}:TRACe{[1]-200}:CORRection:OFFSet:PHASe?
Instruction	This command sets/gets the phase offset of the active trace of selected channel
Parameter Type	Float unit °(radian)
Parameter Range	-360 ~ 360
Return	Float unit °(radian)
Default	0
Menu	Scale > Constants > Phase offset
Example	:CALCulate1:CORRection:OFFSet:PHASe 25 :CALCulate1:CORRection:OFFSet:PHASe? Return: 25 :CALCulate1:TRACe1:CORRection:OFFSet:PHASe 90 :CALCulate1:TRACe1:CORRection:OFFSet:PHASe? Return: 90

3.2.20 Magnitude Offset(:CALCulate{[1]-200}:MEASure{[1]-200}:OFFSet:MAGNitude)

Command Format	:CALCulate{[1]-200}:MEASure{[1]-200}:OFFSet:MAGNitude <numeric> :CALCulate{[1]-200}:MEASure{[1]-200}:OFFSet:MAGNitude?
Instruction	This command sets/gets the magnitude offset of the active trace of selected channel
Parameter Type	Float unit dB
Parameter Range	-1000 ~ 1000
Return	Float unit dB
Default	0
Menu	Scale > Constants > Mag offset
Example	:CALCulate1:MEASure1:OFFSet:MAGNitude 90 :CALCulate1:MEASure1:OFFSet:MAGNitude? Return: 90

3.2.21 Magnitude Slope(:CALCulate{[1]-200}:MEASure{[1]-200}:OFFSet:MAGNitude:SLOPe)

Command Format	:CALCulate{[1]-200}:MEASure{[1]-200}:OFFSet:MAGNitude:SLOPe <numeric> :CALCulate{[1]-200}:MEASure{[1]-200}:OFFSet:MAGNitude:SLOPe?
Instruction	This command sets/gets the magnitude slope of the active trace of selected channel
Parameter Type	Float unit dB/GHz
Parameter Range	-1000 ~ 1000
Return	Float unit dB/GHz
Default	0
Menu	Scale > Constants > Mag Slope
Example	:CALCulate1:MEASure1:OFFSet:MAGNitude:SLOPe 10 :CALCulate1:MEASure1:OFFSet:MAGNitude:SLOPe? Return: 10

3.2.22 X Axis Data(:CALCulate{[1]-200}[:SElected]:DATA:XAXis?)

Command Format	:CALCulate{[1]-200}[:SElected]:DATA:XAXis? :CALCulate{[1]-200}:TRACe{[1]-200}:DATA:XAXis?
Instruction	1. This command reads the data of measurement points of X axis, for the active trace of selected channel. 2. This command reads the data of measurement points of X axis of selected trace for the selected channel.
Parameter Type	Data array(Unit depend on sweep type)
Parameter Range	None
Return	Data array
Default	None
Menu	None
Example	:CALCulate1:DATA:XAXis? :CALCulate1:TRACe1:DATA:XAXis?

3.2.23 Equation State(:CALCulate{[1]-200}[:SElected]:EQUation:STATE)

Command Format	:CALCulate{[1]-200}[:SElected]:EQUation:STATE {ON OFF 1 0} :CALCulate{[1]-200}[:SElected]:EQUation:STATE? :CALCulate{[1]-200}:TRACe{[1]-200}:EQUation:STATE {ON OFF 1 0} :CALCulate{[1]-200}:TRACe{[1]-200}:EQUation:STATE?
Instruction	1. This command enables/disables the Equation Editor of the active trace of selected channel. 2. This command enables/disables the Equation Editor of selected trace for the selected channel.
Parameter Type	Boolean
Parameter Range	ON OFF 1 0
Return	Boolean
Default	OFF
Menu	Math > Analysis > Equation

Example	<pre>:CALCulate1:EQUation:TEXT 'S11/S22' :CALCulate1:EQUation:STATE ON :CALCulate1:EQUation:STATE? Return: 1 :CALCulate1:TRACe1:EQUation:STATE OFF :CALCulate1:TRACe1:EQUation:STATE? Return: 0</pre>
---------	--

3.2.24 Trace Statistics State (:CALCulate{[1]-200}[:SELe cted]:MSTatistics[:STATE])

Command Format	<pre>:CALCulate{[1]-200}[:SELe cted]:MSTatistics[:STATE] {ON OFF 1 0} :CALCulate{[1]-200}[:SELe cted]:MSTatistics[:STATE]? :CALCulate{[1]-200}:TRACe{[1]-200}:MSTatistics[:STATE] {ON OFF 1 0} :CALCulate{[1]-200}:TRACe{[1]-200}:MSTatistics[:STATE]?</pre>
Instruction	This command displays and hides the trace statistics (peak-to-peak, mean, standard deviation) on the screen.
Parameter Type	Boolean
Parameter Range	ON OFF 1 0
Return	Boolean
Default	OFF
Menu	Math > Analysis > Statistics
Example	<pre>:CALCulate1:MSTatistics:STATE 1 :CALCulate1:MSTatistics:STATE? Return: 1 :CALCulate1:TRACe1:MSTatistics:STATE 0 :CALCulate1:TRACe1:MSTatistics:STATE? Return: 0</pre>

3.2.25 Statistics Type (:CALCulate{[1]-200}:MEASure{[1]-200}:FUNCTioN:TYPE)

Command Format	<pre>:CALCulate{[1]-200}:MEASure{[1]-200}:FUNCTioN:TYPE {PTPeak STDEV MEAN} :CALCulate{[1]-200}:MEASure{[1]-200}:FUNCTioN:TYPE?</pre>
Instruction	This command sets statistic type of selected trace for the selected channel.
Parameter Type	Enumeration
Parameter Range	PTPeak STDEV MEAN
Return	Enumeration
Default	PTPeak
Menu	None
Example	<pre>:CALCulate1:MEASure1:FUNCTioN:TYPE MEAN :CALCulate1:MEASure1:FUNCTioN:TYPE? Return: MEAN</pre>

3.2.26 Get Statistics Data (:CALCulate{[1]-200}:TRACe {[1]-200}:MSTatistics:DATA?)

Command Format	:CALCulate{[1]-200}[:SElected]:MSTatistics:DATA? :CALCulate{[1]-200}:TRACe{[1]-200}:MSTatistics:DATA?
Instruction	Returns the trace statistic data for the selected statistic type for the specified channel.
Parameter Type	None
Parameter Range	None
Return	None
Default	None
Menu	None
Example	:CALCulate1:TRACe1:MSTatistics:STATe 1 :CALCulate1:MEASure1:FUNCTion:TYPE MEAN :CALCulate1:TRACe1:MSTatistics:DATA? :CALCulate1:MSTatistics:DATA?

3.2.27 Equation Text (:CALCulate{[1]-200}[:SElected]:EQUation:TEXT)

Command Format	:CALCulate{[1]-200}[:SElected]:EQUation:TEXT <string> :CALCulate{[1]-200}[:SElected]:EQUation:TEXT? :CALCulate{[1]-200}:TRACe{[1]-200}:EQUation:TEXT <string> :CALCulate{[1]-200}:TRACe{[1]-200}:EQUation:TEXT?
Instruction	This command sets/gets the equation in the Equation Editor. For valid parameters that can be used in this equation, refer to the Equation Editor.
Parameter Type	String
Parameter Range	None
Return	String
Default	None
Menu	Math > Analysis > Equation editor
Example	:CALCulate1:EQUation:TEXT "S11/S22" :CALCulate1:EQUation:TEXT? Return: S11/S22 :CALCulate1:TRACe1:EQUation:TEXT "S11/S22" :CALCulate1:TRACe1:EQUation:TEXT? Return: S11/S22

3.2.28 Get Equation Valid (:CALCulate{[1]-200}[:SElected]:EQUation:VALID?)

Command Format	:CALCulate{[1]-200}[:SElected]:EQUation:VALID? :CALCulate{[1]-200}:TRACe{[1]-200}:EQUation:VALID?
Instruction	This command returns False when the equation expression and label are correct but the required S-parameter data is not measured or if it refers the invalid corrected memory array.
Parameter Type	None
Parameter Range	None
Return	Boolean 1: Valid

	0: Invalid
Default	None
Menu	Math > Analysis > Equation editor
Example	:CALCulate1:EQUation:VALID? :CALCulate1:TRACe1:EQUation:VALID?

3.2.29 Transform State (:CALCulate{[1]-200}[:SElected]:TRANSform:TIME:STATE)

Command Format	:CALCulate{[1]-200}[:SElected]:TRANSform:TIME:STATe {ON OFF 1 0} :CALCulate{[1]-200}[:SElected]:TRANSform:TIME:STATe? :CALCulate{[1]-200}:TRACe{[1]-200}:TRANSform:TIME:STATe {ON OFF 1 0} :CALCulate{[1]-200}:TRACe{[1]-200}:TRANSform:TIME:STATe?
Instruction	<ol style="list-style-type: none"> 1. This command turns ON/OFF the transformation function of the time domain function, for the active trace of selected channel. 2. This command turns ON/OFF the transformation function of the time domain function of selected trace for the selected channel.
Parameter Type	Boolean
Parameter Range	{ON OFF 1 0}
Return	Boolean
Default	OFF
Menu	Math > Time Domain > Transform
Example	:CALCulate1:TRANSform:TIME:STATe ON :CALCulate1:TRANSform:TIME:STATe? Return: 1 :CALCulate1:TRACe1:TRANSform:TIME:STATe OFF :CALCulate1:TRACe1:TRANSform:TIME:STATe? Return: 0

3.2.30 Transform Start (:CALCulate{[1]-200}[:SElected]:TRANSform:TIME:START)

Command Format	:CALCulate{[1]-200}[:SElected]:TRANSform:TIME:START <numeric> :CALCulate{[1]-200}[:SElected]:TRANSform:TIME:START? :CALCulate{[1]-200}:TRACe1:TRANSform:TIME:START <numeric> :CALCulate{[1]-200}:TRACe1:TRANSform:TIME:START?
Instruction	<ol style="list-style-type: none"> 1. This command sets/gets the start value of the transformation used for the transformation function of the time domain function, for the active trace of selected channel. 2. This command sets/gets the start value of the transformation used for the transformation function of the time domain function of selected trace for the selected channel.
Parameter Type	float, unit s(second)
Parameter Range	None
Return	Float, unit s(second)
Default	None
Menu	Math > Time Domain > Start Time
Example	:CALCulate1:TRANSform:TIME:START -1e-9 :CALCulate1:TRANSform:TIME:START?

	Return: -1e-09 :CALCulate1:TRACe1:TRANSform:TIME:STARt 1e-9 :CALCulate1:TRACe1:TRANSform:TIME:STARt? Return: 1e-09
--	---

3.2.31 Transform Center (:CALCulate{[1]-200}[:SElecte d]:TRANSform:TIME:CENTer)

Command Format	:CALCulate{[1]-200}[:SElecte d]:TRANSform:TIME:CENTer <numeric> :CALCulate{[1]-200}[:SElecte d]:TRANSform:TIME:CENTer? :CALCulate{[1]-200}:TRACe{[1]-200}:TRANSform:TIME:CENTer <numeric> :CALCulate{[1]-200}:TRACe{[1]-200}:TRANSform:TIME:CENTer?
Instruction	<ol style="list-style-type: none"> 1. This command sets/gets the center value of the transformation used for the transformation function of the time domain function, for the active trace of selected channel 2. This command sets/gets the center value of the transformation used for the transformation function of the time domain function of selected trace for the selected channel.
Parameter Type	Float, unit s(second)
Parameter Range	None
Return	Float, unit s(second)
Default	None
Menu	Math > Time Domain > Center Time
Example	:CALCulate1:TRANSform:TIME:CENTer 12e-9 :CALCulate1:TRANSform:TIME:CENTer? Return: 1.2e-08 :CALCulate1:TRACe1:TRANSform:TIME:CENTer 15e-9 :CALCulate1:TRACe1:TRANSform:TIME:CENTer? Return: 1.5e-08

3.2.32 Transform Stop (:CALCulate{[1]-200}[:SElecte d]:TRANSform:TIME:STOP)

Command Format	:CALCulate{[1]-200}[:SElecte d]:TRANSform:TIME:STOP <numeric> :CALCulate{[1]-200}[:SElecte d]:TRANSform:TIME:STOP? :CALCulate{[1]-200}:TRACe{[1]-200}:TRANSform:TIME:STOP <numeric> :CALCulate{[1]-200}:TRACe{[1]-200}:TRANSform:TIME:STOP?
Instruction	<ol style="list-style-type: none"> 1. This command sets/gets the stop value of the transformation used for the transformation function of the time domain function, for the active trace of selected channel. 2. This command sets/gets the stop value of the transformation used for the transformation function of the time domain function of selected trace for the selected channel.
Parameter Type	Float, unit s(second)
Parameter Range	None
Return	Float, unit s(second)
Default	None
Menu	Math > Time Domain > Stop Time
Example	:CALCulate1:TRANSform:TIME:STOP 20e-9

	:CALCulate1:TRANSform:TIME:STOP? Return: 2e-08
	:CALCulate1:TRACe1:TRANSform:TIME:STOP 15e-9 :CALCulate1:TRACe1:TRANSform:TIME:STOP? Return: 1.5e-08

3.2.33 Transform Span (:CALCulate{[1]-200}[:SElected]:TRANSform:TIME:SPAN)

Command Format	:CALCulate{[1]-200}[:SElected]:TRANSform:TIME:SPAN <numeric> :CALCulate{[1]-200}[:SElected]:TRANSform:TIME:SPAN? :CALCulate{[1]-200}:TRACe{[1]-200}:TRANSform:TIME:SPAN <numeric> :CALCulate{[1]-200}:TRACe{[1]-200}:TRANSform:TIME:SPAN?
Instruction	<ol style="list-style-type: none"> 1. This command sets/gets the span value of the transformation used for the transformation function of the time domain function, for the active trace of selected channel. 2. This command sets/gets the span value of the transformation used for the transformation function of the time domain function of selected trace for the selected channel.
Parameter Type	Float, unit s(second)
Parameter Range	None
Return	Float, unit s(second)
Default	None
Menu	Math > Time Domain > SPAN Time
Example	:CALCulate1:TRANSform:TIME:SPAN 10e-9 :CALCulate1:TRANSform:TIME:SPAN? Return: 1e-08 :CALCulate1:TRACe1:TRANSform:TIME:SPAN 15e-9 :CALCulate1:TRACe1:TRANSform:TIME:SPAN? Return: 1.5e-08

3.2.34 Transform Mode (:CALCulate{[1]-200}[:SElected]:TRANSform:TIME[:TYPE])

Command Format	:CALCulate{[1]-200}[:SElected]:TRANSform:TIME[:TYPE] {BPASs LPASs} :CALCulate{[1]-200}[:SElected]:TRANSform:TIME[:TYPE]? :CALCulate{[1]-200}:TRACe{[1]-200}:TRANSform:TIME[:TYPE] {BPASs LPASs} :CALCulate{[1]-200}:TRACe{[1]-200}:TRANSform:TIME[:TYPE]?
Instruction	<ol style="list-style-type: none"> 1. This command sets/gets the transformation type used for the transformation function of the time domain function, for the active trace of selected channel. 2. This command sets/gets the transformation type used for the transformation function of the time domain function, for the selected trace and selected channel.
Parameter Type	Enumeration
Parameter Range	BPASs LPASs
Return	Enumeration
Default	BPASs
Menu	Math > Time Domain > TD Mode

Example	<pre>:CALCulate1:TRANSform:TIME LPASs :CALCulate1:TRANSform:TIME? Return: LPAS :CALCulate1:TRACe1:TRANSform:TIME BPASs :CALCulate1:TRACe1:TRANSform:TIME? Return: BPAS</pre>
---------	---

3.2.35 Transform Stimulus (:CALCulate{[1]-200}[:SElected]:TRANSform:TIME:STIMulus)

Command Format	<pre>:CALCulate{[1]-200}[:SElected]:TRANSform:TIME:STIMulus {IMPulse STEP} :CALCulate{[1]-200}[:SElected]:TRANSform:TIME:STIMulus? :CALCulate{[1]-200}:TRACe{[1]-200}:TRANSform:TIME:STIMulus {IMPulse STEP} :CALCulate{[1]-200}:TRACe{[1]-200}:TRANSform:TIME:STIMulus?</pre>
Instruction	<ol style="list-style-type: none"> 1. This command sets/gets the stimulus type used for the transformation function of the time domain function, for the active trace of selected channel. 2. This command sets/gets the stimulus type used for the transformation function of the time domain function of selected trace for the selected channel.
Parameter Type	Enumeration
Parameter Range	IMPulse STEP
Return	Enumeration
Default	IMPulse
Menu	Math > Time Domain > TD Mode
Example	<pre>:CALCulate1:TRANSform:TIME LPASs :CALCulate1:TRANSform:TIME:STIMulus STEP :CALCulate1:TRANSform:TIME:STIMulus? Return: STEP :CALCulate1:TRACe1:TRANSform:TIME LPASs :CALCulate1:TRACe1:TRANSform:TIME:STIMulus IMPulse :CALCulate1:TRACe1:TRANSform:TIME:STIMulus? Return: IMP</pre>

3.2.36 Gating State (:CALCulate{[1]-200}[:SElected]:FILTer[:GATE]:TIME:STATe)

Command Format	<pre>:CALCulate{[1]-200}[:SElected]:FILTer[:GATE]:TIME:STATe {ON OFF 1 0} :CALCulate{[1]-200}[:SElected]:FILTer[:GATE]:TIME:STATe? :CALCulate{[1]-200}:TRACe{[1]-200}:FILTer[:GATE]:TIME:STATe {ON OFF 1 0} :CALCulate{[1]-200}:TRACe{[1]-200}:FILTer[:GATE]:TIME:STATe?</pre>
Instruction	<ol style="list-style-type: none"> 1. This command turns ON/OFF the gating function of the time domain function, for the active trace of selected channel. 2. This command turns ON/OFF the gating function of the time domain function of selected trace for the selected channel.
Parameter Type	Boolean
Parameter Range	ON OFF 1 0
Return	Boolean
Default	OFF
Menu	Math > Time Gating > Gating
Example	<pre>:CALCulate1:FILTer:TIME:STATe ON</pre>

	:CALCulate1:FILTer:TIME:STATe? Return: 1
	:CALCulate1:TRACe1:FILTer:TIME:STATe OFF :CALCulate1:TRACe1:FILTer:TIME:STATe? Return: 0

3.2.37 Gating Start (:CALCulate{[1]-200}[:SElected]:FILTer[:GATE]:TIME:STARt)

Command Format	:CALCulate{[1]-200}[:SElected]:FILTer[:GATE]:TIME:STARt <numeric> :CALCulate{[1]-200}[:SElected]:FILTer[:GATE]:TIME:STARt? :CALCulate{[1]-200}:TRACe{[1]-200}:FILTer[:GATE]:TIME:STARt <numeric> :CALCulate{[1]-200}:TRACe{[1]-200}:FILTer[:GATE]:TIME:STARt?
Instruction	<ol style="list-style-type: none"> 1. This command sets/gets the start value of the gate used for the gating function of the time domain function, for the active trace of selected channel. 2. This command sets/gets the start value of the gate used for the gating function of the time domain function of selected trace for the selected channel.
Parameter Type	Float, unit s(second)
Parameter Range	-250e-9, 250e-9
Return	float, unit s(second)
Default	-250e-9
Menu	Math > Time Gating > Gate Start
Example	:CALCulate1:FILTer:TIME:STARt -1e-9 :CALCulate1:FILTer:TIME:STARt? Return: -1e-09 :CALCulate1:TRACe1:FILTer:TIME:STARt -2e-9 :CALCulate1:TRACe1:FILTer:TIME:STARt? Return: -2e-09

3.2.38 Gating Center (:CALCulate{[1]-200}[:SElected]:FILTer[:GATE]:TIME:CENTer)

Command Format	:CALCulate{[1]-200}[:SElected]:FILTer[:GATE]:TIME:CENTer <numeric> :CALCulate{[1]-200}[:SElected]:FILTer[:GATE]:TIME:CENTer? :CALCulate{[1]-200}:TRACe{[1]-200}:FILTer[:GATE]:TIME:CENTer <numeric> :CALCulate{[1]-200}:TRACe{[1]-200}:FILTer[:GATE]:TIME:CENTer?
Instruction	<ol style="list-style-type: none"> 1. This command sets/gets the center value of the gate used for the gating function of the time domain function, for the active trace of selected channel. 2. This command sets/gets the center value of the gate used for the gating function of the time domain function of selected trace for the selected channel.
Parameter Type	Float, unit s(second)
Parameter Range	None
Return	float, unit s(second)
Default	0
Menu	Math > Time Gating > Gate Center
Example	:CALCulate1:FILTer:TIME:CENTer 10e-9 :CALCulate1:FILTer:TIME:CENTer? Return: 1e-08

	:CALCulate1:TRACe1:FILTer:TIME:CENTer 12e-9 :CALCulate1:TRACe1:FILTer:TIME:CENTer? Return: 1.2e-08
--	--

3.2.39 Gating Stop (:CALCulate{[1]-200}[:SElected]:FILTer[:GATE]:TIME:STOP)

Command Format	:CALCulate{[1]-200}[:SElected]:FILTer[:GATE]:TIME:STOP <numeric> :CALCulate{[1]-200}[:SElected]:FILTer[:GATE]:TIME:STOP? :CALCulate{[1]-200}:TRACe{[1]-200}:FILTer[:GATE]:TIME:STOP <numeric> :CALCulate{[1]-200}:TRACe{[1]-200}:FILTer[:GATE]:TIME:STOP?
Instruction	1. This command sets/gets the stop value of the gate used for the gating function of the time domain function, for the active trace of selected channel. 2. This command sets/gets the stop value of the gate used for the gating function of the time domain function of selected trace for the selected channel.
Parameter Type	Float, unit s(second)
Parameter Range	-250e-9, 250e-9
Return	float, unit s(second)
Default	250e-9
Menu	Math > Time Gating > Gate Stop
Example	:CALCulate1:FILTer:TIME:STOP 10e-9 :CALCulate1:FILTer:TIME:STOP? Return: 1e-08 :CALCulate1:TRACe1:FILTer:TIME:STOP 15e-9 :CALCulate1:TRACe1:FILTer:TIME:STOP? Return: 1.5e-08

3.2.40 Gating Span (:CALCulate{[1]-200}[:SElected]:FILTer[:GATE]:TIME:SPAN)

Command Format	:CALCulate{[1]-200}[:SElected]:FILTer[:GATE]:TIME:SPAN <numeric> :CALCulate{[1]-200}[:SElected]:FILTer[:GATE]:TIME:SPAN? :CALCulate{[1]-200}:TRACe{[1]-200}:FILTer[:GATE]:TIME:SPAN <numeric> :CALCulate{[1]-200}:TRACe{[1]-200}:FILTer[:GATE]:TIME:SPAN?
Instruction	1. This command sets/gets the span value of the gate used for the gating function of the time domain function, for the active trace of selected channel. 2. This command sets/gets the span value of the gate used for the gating function of the time domain function of selected trace for the selected channel.
Parameter Type	Float, unit s(second)
Parameter Range	None
Return	float, unit s(second)
Default	500e-9
Menu	Math > Time Gating > Gate Span
Example	:CALCulate1:FILTer:TIME:SPAN 10e-9 :CALCulate1:FILTer:TIME:SPAN? Return: 1e-08 :CALCulate1:TRACe1:FILTer:TIME:SPAN 15e-9 :CALCulate1:TRACe1:FILTer:TIME:SPAN? Return: 1.5e-08

3.2.41 Gating Shape (:CALCulate{[1]-200}[:SElected]:FILTer[:GATE]:TIME:SHAPE)

Command Format	:CALCulate{[1]-200}[:SElected]:FILTer[:GATE]:TIME:SHAPE {MAXimum WIDE NORMal MINimum} :CALCulate{[1]-200}[:SElected]:FILTer[:GATE]:TIME:SHAPE? :CALCulate{[1]-200}:TRACe{[1]-200}:FILTer[:GATE]:TIME:SHAPE {MAXimum WIDE NORMal MINimum} :CALCulate{[1]-200}:TRACe{[1]-200}:FILTer[:GATE]:TIME:SHAPE?
Instruction	<ol style="list-style-type: none"> 1. This command sets/gets the shape of the gate used for the gating function of the time domain function, for the active trace of selected channel. 2. This command sets/gets the shape of the gate used for the gating function of the time domain function of selected trace for the selected channel.
Parameter Type	Enumeration
Parameter Range	MAXimum WIDE NORMal MINimum
Return	Enumeration
Default	NORMal
Menu	Math > Time Gating > Gate Shape
Example	<pre>:CALCulate1:FILTer:TIME:SHAPE MINimum :CALCulate1:FILTer:TIME:SHAPE? Return: MIN :CALCulate1:TRACe1:FILTer:TIME:SHAPE WIDE :CALCulate1:TRACe1:FILTer:TIME:SHAPE? Return: WIDE</pre>

3.2.42 Gating Type (:CALCulate{[1]-200}[:SElected]:FILTer[:GATE]:TIME:TYPE)

Command Format	:CALCulate{[1]-200}[:SElected]:FILTer[:GATE]:TIME:TYPE {BPASs NOTCh} :CALCulate{[1]-200}[:SElected]:FILTer[:GATE]:TIME:TYPE? :CALCulate{[1]-200}:TRACe{[1]-200}:FILTer[:GATE]:TIME:TYPE { BPASs NOTCh} :CALCulate{[1]-200}:TRACe{[1]-200}:FILTer[:GATE]:TIME:TYPE?
Instruction	<ol style="list-style-type: none"> 1. This command sets/gets the type of the gate used for the gating function of the time domain function, for the active trace of selected channel. 2. This command sets/gets the type of the gate used for the gating function of the time domain function of selected trace for the selected channel.
Parameter Type	Enumeration
Parameter Range	BPASs NOTCh
Return	Enumeration
Default	BPASs
Menu	Math > Time Gating > Gate Type
Example	<pre>:CALCulate1:FILTer:TIME:TYPE NOTCh :CALCulate1:FILTer:TIME:TYPE? Return: NOTC :CALCulate1:TRACe1:FILTer:TIME:TYPE BPASs :CALCulate1:TRACe1:FILTer:TIME:TYPE? Return: BPAS</pre>

3.2.43 Trace Format (:CALCulate{[1]-200}[:SElected]:FORMat)

Command Format	:CALCulate{[1]-200}[:SElected]:FORMat { MLOGarithmic PHASe GDELay SLINear SLOGarithmic SCOMplex SMITH SADMittance PLINear PLOGarithmic POLar MLINear SWR REAL IMAGinary UPHase PPHase} :CALCulate{[1]-200}[:SElected]:FORMat? :CALCulate{[1]-200}:TRACe{[1]-200}:FORMat {MLOGarithmic PHASe GDELay SLINear SLOGarithmic SCOMplex SMITH SADMittance PLINear PLOGarithmic POLar MLINear SWR REAL IMAGinary UPHase PPHase} :CALCulate{[1]-200}:TRACe{[1]-200}:FORMat?
Instruction	1. This command sets/gets the data format of the active trace of selected channel. 2. This command sets/gets the data format of selected trace for the selected channel.
Parameter Type	Enumeration
Parameter Range	MLOGarithmic PHASe GDELay SLINear SLOGarithmic SCOMplex SMITH SADMittance PLINear PLOGarithmic POLar MLINear SWR REAL IMAGinary UPHase PPHase
Return	Enumeration
Default	MLOGarithmic
Menu	Format > Format1 or Format2
Example	:CALCulate1:FORMat PHASe :CALCulate1:FORMat? Return: PHAS :CALCulate1:TRACe1:FORMat GDELay :CALCulate1:TRACe1:FORMat? Return: GDEL

3.2.44 Limit Table (:CALCulate{[1]-200}[:SElected]:LIMit:DATA)

Command Format	:CALCulate{[1]-200}[:SElected]:LIMit:DATA <numeric 1>, ... ,<numeric 1+(N*5)> :CALCulate{[1]-200}[:SElected]:LIMit:DATA? :CALCulate{[1]-200}:TRACe{[1]-200}:LIMit:DATA <numeric 1>, ... ,<numeric 1+(N*5)> :CALCulate{[1]-200}:TRACe{[1]-200}:LIMit:DATA?
Instruction	1. This command sets/gets the limit table for the limit test, for the active trace of selected channel 2. This command sets/gets the limit table for the limit test of selected trace for the selected channel.
Parameter Type	Data Array
Parameter Range	Indicates the array data (for limit line) of 1 + Num (number of limit lines)*5. Where n is an integer between 1 and Num. Data(0) :The number of limit lines you want to set. Specify an integer ranging 0 to 100. When the number of limit lines is set to 0 (clears the limit table), the variable Data is only required with Data(0). Data(n*5-4) :The type of the n-th line.

	<p>Specify an integer 0 to 2 as follows. 0:OFF 1:Upper limit line 2:Lower limit line</p> <p>Data(n*5-3) :The value on the horizontal axis (frequency/power/time) of the start point of the n-th line.</p> <p>Data(n*5-2) :The value on the horizontal axis (frequency/power/time) of the end point of the n-th line.</p> <p>Data(n*5-1) :The value on the vertical axis of the start point of the n-th line.</p> <p>Data(n*5) :The value on the vertical axis of the end point of the n-th line.</p> <p>The index of the array starts from 0.</p>
Return	Data Array
Default	None
Menu	Math > Analysis > Limit Table
Example	<pre>:CALCulate1:LIMit:DATA 2,1,1E9,3E9,0,0,2,1E9,3E9,-3,-3 :CALCulate1:LIMit:DATA? Return: 2,1,1000000000,3000000000,0,0,2,1000000000,3000000000,-3,-3 :CALCulate1:TRACe1:LIMit:DATA 2,2,2E9,3E9,-3,0,1,2E9,3E9,-5,-3 :CALCulate1:TRACe1:LIMit:DATA? Return: 2,2,2000000000,3000000000,-3,0,1,2000000000,3000000000,-5,-3</pre>

3.2.45 Limit Line State (:CALCulate{[1]-200}[:SElected]:LIMit:DISPlay[:STATe])

Command Format	<pre>:CALCulate{[1]-200}[:SElected]:LIMit:DISPlay[:STATe] {ON OFF 1 0} :CALCulate{[1]-200}[:SElected]:LIMit:DISPlay[:STATe]? :CALCulate{[1]-200}:TRACe{[1]-200}:LIMit:DISPlay[:STATe] {ON OFF 1 0} :CALCulate{[1]-200}:TRACe{[1]-200}:LIMit:DISPlay[:STATe]?</pre>
Instruction	<ol style="list-style-type: none"> This command turns ON/OFF the limit line display, for the active trace of selected channel. This command turns ON/OFF the limit line display of selected trace for the selected channel.
Parameter Type	Boolean
Parameter Range	ON OFF 1 0
Return	Boolean
Default	OFF
Menu	Math > Analysis > Limit > Limit Line ON
Example	<pre>:CALCulate1:LIMit:DISPlay ON :CALCulate1:LIMit:DISPlay? Return: 1 :CALCulate1:TRACe1:LIMit:DISPlay OFF :CALCulate1:TRACe1:LIMit:DISPlay? Return: 0</pre>

3.2.46 Get Limit Test Result (:CALCulate{[1]-200}[:SElected]:LIMit:FAIL?)

Command Format	:CALCulate{[1]-200}[:SElected]:LIMit:FAIL? :CALCulate{[1]-200}:TRACe{[1]-200}:LIMit:FAIL?
Instruction	1. This command reads the limit test result, for the active trace of selected channel. 2. This command reads the limit test result of selected trace for the selected channel.
Parameter Type	None
Parameter Range	None
Return	1 0 1: Fail 0: Pass
Default	None
Menu	None
Example	:CALCulate1:LIMit:FAIL? :CALCulate1:TRACe1:LIMit:FAIL?

3.2.47 Limit Sound State (:CALCulate{[1]-200}[:SElected]:LIMit:SOUNd[:STATE])

Command Format	:CALCulate{[1]-200}:TRACe{[1]-200}:LIMit:SOUNd[:STATE] {ON OFF 1 0} :CALCulate{[1]-200}:TRACe{[1]-200}:LIMit:SOUNd[:STATE]?
Instruction	This command turns ON/OFF the limit testing fail sound of selected trace for the selected channel.
Parameter Type	Boolean
Parameter Range	ON OFF 1 0
Return	Boolean
Default	OFF
Menu	Math > Analysis > Limit > Test Sound ON
Example	:CALCulate1:MEASure:LIMit:SOUNd ON :CALCulate1:MEASure:LIMit:SOUNd? Return: 1

3.2.48 Get Limit All Report (:CALCulate{[1]-200}[:SElected]:LIMit:REPort:ALL?)

Command Format	:CALCulate{[1]-200}[:SElected]:LIMit:REPort:ALL? :CALCulate{[1]-200}:TRACe{[1]-200}:LIMit:REPort:ALL?
Instruction	This command reads the bandwidth test results (stimulus value, limit test result, upper limit value and lower limit value of all measurement points), for the active trace of selected channel
Parameter Type	None
Parameter Range	None
Return	Data array

	<p>Indicates the array data (for limit line) of NOP (number of measurement points)x 4. Where n is an integer between 1 and NOP.</p> <ul style="list-style-type: none"> ● Data(nx4-3) The stimulus value for the measurement point. ● Data(nx4-2) The limit test result. Specify an integer -1 to 1 as follows. -1:No limit 0:Fail 1:Pass ● Data(nx4-1) The upper limit value at the measurement point. (If there is no limit at this point, reads out the 0.) ● Data(nx4) The lower limit value at the measurement point. (If there is no limit at this point, reads out the 0.) <p>The index of the array starts from 0.</p>
Default	None
Menu	None
Example	:CALCulate1:LIMit:REPort:ALL? :CALCulate1:TRACe1:LIMit:REPort:ALL?

3.2.49 Get Limit Failed Data (:CALCulate{[1]-200}[:SElected]:LIMit:REPort[:DATA]?)

Command Format	:CALCulate{[1]-200}[:SElected]:LIMit:REPort[:DATA]? :CALCulate{[1]-200}:TRACe{[1]-200}:LIMit:REPort[:DATA]?
Instruction	This command reads the stimulus values (frequency, power level or time) at all the measurement points that failed the limit test, for the active trace of selected channel.
Parameter Type	None
Parameter Range	None
Return	Data array Indicates the array data for failed measurement points.
Default	None
Menu	None
Example	:CALCulate1:LIMit:REPort? :CALCulate1:TRACe1:LIMit:REPort?

3.2.50 Get Limit Failed Points (:CALCulate{[1]-200}[:SElected]:LIMit:REPort:POINTs?)

Command Format	:CALCulate{[1]-200}[:SElected]:LIMit:REPort:POINTs? :CALCulate{[1]-200}:TRACe{[1]-200}:LIMit:REPort:POINTs?
Instruction	This command reads the number of the measurement points that failed the limit test, for the active trace of selected channel.
Parameter Type	None
Parameter Range	None
Return	Integer
Default	None
Menu	None

Example	:CALCulate1:LIMit:REPort:POINts? :CALCulate1:TRACe1:LIMit:REPort:POINts?
---------	---

3.2.51 Limit Test State (:CALCulate{[1]-200}[:SElected]:LIMit[:STATe])

Command Format	:CALCulate{[1]-200}[:SElected]:LIMit[:STATe] {ON OFF 1 0} :CALCulate{[1]-200}[:SElected]:LIMit[:STATe]? :CALCulate{[1]-200}:TRACe{[1]-200}:LIMit[:STATe] {ON OFF 1 0} :CALCulate{[1]-200}:TRACe{[1]-200}:LIMit[:STATe]?
Instruction	This command turns ON/OFF the limit test function, for the active trace of selected channel.
Parameter Type	Boolean
Parameter Range	ON OFF 1 0
Return	Boolean
Default	OFF
Menu	Math > Analysis > Limit > Limit Test ON
Example	:CALCulate1:LIMit ON :CALCulate1:LIMit? Return: 1 :CALCulate1:TRACe1:LIMit OFF :CALCulate1:TRACe1:LIMit? Return: 0

3.2.52 Active Marker (:CALCulate{[1]-200}[:SElected]:MARKer{[1]-10}:ACTivate)

Command Format	:CALCulate{[1]-200}[:SElected]:MARKer{[1]-10}:ACTivate :CALCulate{[1]-200}:TRACe{[1]-200}:MARKer{[1]-10}:ACTivate
Instruction	This command sets the marker 1 to 9 (Mk) and reference marker (Mk:10) to the active marker. The marker on a trace that can be repositioned either by front panel controls or by programming commands, for the active trace of selected channel.
Parameter Type	Long
Parameter Range	1 to 10 (10 is for the reference marker)
Default	None
Menu	Marker > Select
Example	:CALCulate1:MARKer3:ACTivate :CALCulate1:TRACe1:MARKer3:ACTivate

3.2.53 Bandwidth Search Result of Marker (:CALCulate{[1]-200}[:SElected]:MARKer{[1]-10}:BWIDth:DATA?)

Command Format	:CALCulate{[1]-200}[:SElected]:MARKer{[1]-10}:BWIDth:DATA? :CALCulate{[1]-200}:TRACe{[1]-200}:MARKer{[1]-10}:BWIDth:DATA?
Instruction	This command reads the bandwidth search result of marker 1 to 9 (Mk) and reference marker (Mk:10), for the active trace of selected channel.

Parameter Type	None
Parameter Range	None
Return	Indicates 4-element array data (bandwidth search result). <ul style="list-style-type: none"> ● Data(0) :The bandwidth. ● Data(1) :Center point frequency of the 2 cutoff frequency points. ● Data(2) :The Q value. ● Data(3) :Insertion loss The index of the array starts from 0. The bandwidth search enable switch must to be turned on before query the search result.
Default	None
Menu	None
Example	:CALCulate1:MEASure1:MARKer3 ON :CALCulate1:MARKer:BWIDth ON :CALCulate1:MARKer3:BWIDth:DATA? :CALCulate1:TRACe1:MARKer3:BWIDth:DATA? Return: 254357919.225087,4162270498.174748,16.363833,-13.946911

3.2.54 Bandwidth Search Result State of Marker (:CALCulate{[1]-200}[:SElected]:MARKer{[1]-10}:BWIDth[:STATE])

Command Format	:CALCulate{[1]-200}[:SElected]:MARKer{[1]-10}:BWIDth[:STATE] {ON OFF 1 0} :CALCulate{[1]-200}[:SElected]:MARKer{[1]-10}:BWIDth[:STATE]? :CALCulate{[1]-200}:TRACe{[1]-200}:MARKer{[1]-10}:BWIDth[:STATE] {ON OFF 1 0} :CALCulate{[1]-200}:TRACe{[1]-200}:MARKer{[1]-10}:BWIDth[:STATE]?
Instruction	1. This command turns ON/OFF the bandwidth search result display, for the active trace of selected channel; 2. This command turns ON/OFF the bandwidth search result display, for the selected trace of selected channel.
Parameter Type	Boolean
Parameter Range	ON OFF 1 0
Return	Boolean
Default	OFF
Menu	None
Example	:CALCulate1:TRACe1:MARKer1 ON :CALCulate1:MARKer1:BWIDth ON :CALCulate1:MARKer1:BWIDth? Return: 1 :CALCulate1:TRACe1:MARKer:BWIDth OFF :CALCulate1:TRACe1:MARKer:BWIDth? Return: 0

3.2.55 Bandwidth Threshold of Marker (:CALCulate{[1]-200}[:SElected]:MARKer{[1]-10}:BWIDth:THReshold)

Command Format	:CALCulate{[1]-200}[:SElected]:MARKer{[1]-10}:BWIDth:THReshold <numeric> :CALCulate{[1]-200}[:SElected]:MARKer{[1]-10}:BWIDth:THReshold? :CALCulate{[1]-200}:TRACe{[1]-200}:MARKer{[1]-10}:BWIDth:THReshold <num
----------------	--

	eric> :CALCulate{[1]-200}:TRACe{[1]-200}:MARKer{[1]-10}:BWIDth:THReshold?
Instruction	This command sets/gets the bandwidth definition value (the value to define the pass-band of the filter) of marker 1 to 9 (Mk) and reference marker (Mk:10), for the active trace of selected channel.
Parameter Type	Float
Parameter Range	-20-120
Return	Float
Default	-3
Menu	Search > Bandwidth > BW Level
Example	:CALCulate1:MARKer1:BWIDth:THReshold -3.5 :CALCulate1:MARKer1:BWIDth:THReshold? Return: -3.5 :CALCulate1:TRACe1:MARKer1:BWIDth:THReshold -6 :CALCulate1:TRACe1:MARKer1:BWIDth:THReshold? Return: -6

3.2.56 Marker Couple (:CALCulate:MARKer:COUPle)

Command Format	:CALCulate:MARKer:COUPle {ALL CHANnel OFF} :CALCulate:MARKer:COUPle?
Instruction	This command sets the marker coupling state.
Parameter Type	Enumeration
Parameter Range	ALL CHANnel OFF
Return	ALL CHAN OFF
Default	OFF
Menu	Marker > Marker Setup > Coupled
Example	:CALCulate:MARKer:COUPle ALL :CALCulate:MARKer:COUPle? Return: ALL

3.2.57 Get Response and Stimulus Data of Marker (:CALCulate{[1]-200}[:SElected]:MARKer{[1]-10}:DATA?)

Command Format	:CALCulate{[1]-200}[:SElected]:MARKer{[1]-10}:DATA? :CALCulate{[1]-200}:TRACe{[1]-200}:MARKer{[1]-10}:DATA?
Instruction	1. This command reads the response and stimulus value of marker 1 to 9 (Mk) and reference marker (Mk:10), for the active trace of selected channel. 2. This command reads the response and stimulus value of marker 1 to 9 (Mk) and reference marker (Mk:10), for the selected trace of selected channel.
Parameter Type	None
Parameter Range	None
Return	Data array Indicates 3-element array data (response and stimulus of marker). ● Data(0) :Response value (primary value) at the marker position.

	<ul style="list-style-type: none"> ● Data(1) :Response value (secondary value) at the marker position. Always 0 when the data format is not the Smith chart format or the polar format. ● Data(2) :Stimulus value at the marker position. <p>The index of the array starts from 0.</p>
Default	None
Menu	None
Example	:CALCulate1:MARKer3:DATA? :CALCulate1:TRACe1:MARKer3:DATA?

3.2.58 Marker Discrete (:CALCulate{[1]-200}[:SElecte d]:MARKer{[1]-10}:DISCcrete)

Command Format	:CALCulate{[1]-200}[:SElecte d]:MARKer{[1]-10}:DISCcrete {ON OFF 1 0} :CALCulate{[1]-200}[:SElecte d]:MARKer{[1]-10}:DISCcrete? :CALCulate{[1]-200}:TRACe{[1]-200}:MARKer{[1]-10}:DISCcrete {ON OFF 1 0} :CALCulate{[1]-200}:TRACe{[1]-200}:MARKer{[1]-10}:DISCcrete?
Instruction	This command turns ON/OFF the discrete mode (mode in which the marker moves only at the measurement points) with marker 1 to 9 (Mk) and reference marker (Mk:10), for the active trace of selected channel.
Parameter Type	Boolean
Parameter Range	ON OFF 1 0
Return	Boolean
Default	OFF
Menu	Marker > Marker Setup > DISCcrete
Example	:CALCulate1:MARKer2:DISCcrete ON :CALCulate1:MARKer2:DISCcrete? Return: 1 :CALCulate1:TRACe1:MARKer3:DISCcrete OFF :CALCulate1:TRACe1:MARKer3:DISCcrete? Return: 0

3.2.59 Marker Delta (:CALCulate{[1]-200}:MEASure{[1]-200}:MARKer{[1]-10}:DELTA)

Command Format	:CALCulate{[1]-200}:MEASure{[1]-200}:MARKer{[1]-9}:DELTA {ON OFF 1 0} :CALCulate{[1]-200}:MEASure{[1]-200}:MARKer{[1]-9}:DELTA?
Instruction	This command turns ON/OFF the delta marker state, for the selected trace of selected channel.
Parameter Type	Boolean
Parameter Range	ON OFF 1 0
Return	Boolean
Default	OFF
Menu	Marker > Marker Setup > Delta
Example	:CALCulate1:MEASure:MARKer3:DELTA ON :CALCulate1:MEASure:MARKer3:DELTA? Return: 1

3.2.60 Marker Type (:CALCulate{[1]-200}:MEASure{[1]-200}:MARKer{[1]-10}:TYPE)

Command Format	:CALCulate{[1]-200}:MEASure{[1]-200}:MARKer{[1]-10}:TYPE {NORMal FIXed} :CALCulate{[1]-200}:MEASure{[1]-200}:MARKer{[1]-10}:TYPE?
Instruction	This command sets the type of marker 1 to 9 (Mk) and reference marker (Mk:10), for the selected trace of selected channel.
Parameter Type	Enumeration
Parameter Range	NORMal FIXed
Return	Enumeration
Default	NORM
Menu	Marker > Marker Setup > Type
Example	:CALCulate1:MEASure:MARKer3:TYPE FIXed :CALCulate1:MEASure:MARKer3:TYPE? Return: FIX

3.2.61 Marker Format (:CALCulate{[1]-200}:MEASure{[1]-200}:MARKer{[1]-10}:FORMAT)

Command Format	:CALCulate{[1]-200}:MEASure{[1]-200}:MARKer{[1]-10}:FORMAT {DEFault MLINear MLOGarithmic IMPedance ADMittance PHASe IMAGinary REAL POLar GDElay LINPhase LOGPhase SWR} :CALCulate{[1]-200}:MEASure{[1]-200}:MARKer{[1]-10}:FORMAT?
Instruction	This command sets the measure format with marker 1 to 9 and reference marker (Mk:10), for the selected trace of selected channel.
Parameter Type	Enumeration
Parameter Range	DEFault MLINear MLOGarithmic IMPedance ADMittance PHASe IMAGinary REAL POLar GDElay LINPhase LOGPhase SWR
Return	Enumeration
Default	DEF
Menu	Marker > Marker Setup > FORMat
Example	:CALCulate1:MEASure1:MARKer3:FORMAT MLINear :CALCulate1:MEASure1:MARKer3:FORMAT? Return: MLIN

3.2.62 Marker State (:CALCulate{[1]-200}:MEASure{[1]-200}:MARKer{[1]-10}[:STATe])

Command Format	:CALCulate{[1]-200}:MEASure{[1]-200}:MARKer{[1]-10}[:STATe] {ON OFF 1 0} :CALCulate{[1]-200}:MEASure{[1]-200}:MARKer{[1]-10}[:STATe]?
Instruction	This command turns ON/OFF the display of marker 1 to 9 and reference marker (Mk:10), for the selected trace of selected channel.
Parameter Type	Boolean
Parameter Range	ON OFF 1 0
Return	Boolean
Default	OFF
Menu	None
Example	:CALCulate1:MEASure1:MARKer3 ON

	:CALCulate1:MEASure1:MARKer3? Return: 1
--	--

3.2.63 Marker State (:CALCulate{[1]-200}[:SElected]:M ARKer{[1]-10}[:STATe])

Command Format	:CALCulate{[1]-200}[:SElected]:MARKer{[1]-10}[:STATe] {ON OFF 1 0} :CALCulate{[1]-200}[:SElected]:MARKer{[1]-10}[:STATe]? :CALCulate{[1]-200}:TRACe{[1]-200}:MARKer{[1]-10}[:STATe] {ON OFF 1 0} :CALCulate{[1]-200}:TRACe{[1]-200}:MARKer{[1]-10}[:STATe]?
Instruction	1. This command turns ON/OFF the display of marker 1 to 9 and reference marker (Mk:10), for the active trace of selected channel; 2. This command turns ON/OFF the display of marker 1 to 9 and reference marker (Mk:10), for the selected trace of selected channel.
Parameter Type	Boolean
Parameter Range	ON OFF 1 0
Return	Boolean
Default	OFF
Menu	None
Example	:CALCulate1:MARKer3 ON :CALCulate1:MARKer3? Return: 1 :CALCulate1:TRACe1:MARKer3 OFF :CALCulate1:TRACe1:MARKer3? Return: 0

3.2.64 Reference Marker State (:CALCulate{[1]-200}[:SElected]:MARKer:REFerence[:STATe])

Command Format	:CALCulate{[1]-200}[:SElected]:MARKer:REFerence[:STATe] {ON OFF 1 0} :CALCulate{[1]-200}[:SElected]:MARKer:REFerence[:STATe]? :CALCulate{[1]-200}:TRACe{[1]-200}:MARKer:REFerence[:STATe] {ON OFF 1 0} :CALCulate{[1]-200}:TRACe{[1]-200}:MARKer:REFerence[:STATe]?
Instruction	1. This command turns ON/OFF the reference marker for the active trace of selected channel; 2. This command turns ON/OFF the reference marker for the selected trace of selected channel.
Parameter Type	Boolean
Parameter Range	ON OFF 1 0
Return	Boolean
Default	OFF
Menu	Marker > Reference Marker
Example	:CALCulate1:MARKer:REFerence ON :CALCulate1:MARKer:REFerence? Return: 1 :CALCulate1:TRACe1:MARKer:REFerence OFF :CALCulate1:TRACe1:MARKer:REFerence? Return: 0

3.2.65 All Marker Off(:CALCulate{[1]-200}:MEASure{[1]-200}:MARKer:AOFF)

Command Format	:CALCulate{[1]-200}:MEASure{[1]-200}:MARKer:AOFF
Instruction	This command turns OFF all markers for the selected trace of selected channel.
Parameter Type	None
Parameter Range	None
Return	Boolean
Default	None
Menu	Marker > All Off
Example	:CALCulate1:TRACe1:MARKer3 ON :CALCulate1:MEASure1:MARKer:AOFF

3.2.66 Marker Function (:CALCulate{[1]-200}[:SElecte d]:MARKer{[1]-10}:SET)

Command Format	:CALCulate{[1]-200}[:SElecte d]:MARKer{[1]-10}:SET {START STOP CENTer RLEVel DELay RMARker SPAN} :CALCulate1:TRACe1:MARKer{[1]-10}:SET {START STOP CENTer RLEVel DELay RMARker SPAN}
Instruction	<ol style="list-style-type: none"> This command sets the value at the position of marker 1 to 9 (Mk) and reference marker (Mk:10) to the value of the instrument setting item (Param), for the active trace of selected channel. This command sets the value at the position of marker 1 to 9 (Mk) and reference marker (Mk:10) to the value of the instrument setting item (Param), for the selected trace of selected channel.
Parameter Type	Enumeration
Parameter Range	START STOP CENTer RLEVel DELay RMARker SPAN
Return	None
Default	None
Menu	Marker > Marker Function
Example	:CALCulate1:MARKer1:SET RLEVel :CALCulate1:TRACe1:MARKer1:SET START

3.2.67 Marker X Value (:CALCulate{[1]-200}[:SElecte d]:MARKer{[1]-10}:X)

Command Format	:CALCulate{[1]-200}[:SElecte d]:MARKer:X <numeric> :CALCulate{[1]-200}[:SElecte d]:MARKer:X? :CALCulate{[1]-200}:TRACe{[1]-200}:MARKer:X <numeric> :CALCulate{[1]-200}:TRACe{[1]-200}:MARKer:X?
Instruction	<ol style="list-style-type: none"> This command set the stimulus value for marker 1 to 9 (Mk) and reference marker (Ch:10), for the active trace of selected channel. This command set the stimulus value for marker 1 to 9 (Mk) and reference marker (Ch:10), for the a selected ctive trace of selected channel.
Parameter Type	Float
Parameter Range	9k~8.5GHz

Return	float
Default	None
Menu	Marker> Marker x(x: 1-9 and R)
Example	:CALCulate1:MARKer1:X 1e9 :CALCulate1:MARKer1:X? Return: 1000000000 :CALCulate1:TRACe1:MARKer:X 2e9 :CALCulate1:TRACe1:MARKer:X? Return: 2000000000

3.2.68 Get Marker Y Value (:CALCulate{[1]-200}[:SElected]:MARKer{[1]-10}:Y?)

Command Format	:CALCulate{[1]-200}[:SElected]:MARKer{[1]-200}:Y? :CALCulate{[1]-200}:TRACe{[1]-200}:MARKer{[1]-200}:Y?
Instruction	<ol style="list-style-type: none"> This command reads the response value of marker 1 to 9 (Mk) and reference marker (Mk:10), for the active trace of selected channel. This command reads the response value of marker 1 to 9 (Mk) and reference marker (Mk:10), for the selected trace of selected channel.
Parameter Type	None
Parameter Range	None
Return	<p>Data array</p> <p>Indicates 2-element array data (response value of marker).</p> <ul style="list-style-type: none"> Data(0) :Response value (primary value) at the marker position. Data(1) :Response value (secondary value) at the marker position. Always 0 when the data format is not the Smith chart format or the polar format. <p>The index of the array starts from 0.</p>
Default	None
Menu	None
Example	:CALCulate1:MARKer1:Y? :CALCulate1:TRACe1:MARKer1:Y?

3.2.69 Add Search Domain (:CALCulate1 [:SElected]:MARKer:FUNCTION:DOMAIN:ADD)

Command Format	:CALCulate{[1]-200}[:SElected]:MARKer:FUNCTION:DOMAIN:ADD
Instruction	This command adds search range of search analysis for the selected marker, for the active trace of selected channel.
Parameter Type	None
Parameter Range	None
Return	None
Default	None
Menu	Search > Domain > Add
Example	:CALCulate1:MARKer:FUNCTION:DOMAIN:ADD

3.2.70 Delete Search Domain (:CALCulate1 [:SElected]:MARKer:FUNcTion:DOMain:DELeTe)

Command Format	:CALCulate{[1]-200} [:SElected]:MARKer:FUNcTion:DOMain:DELeTe <numeric>
Instruction	This command deletes search range of search analysis for the selected marker, for the active trace of selected channel.
Parameter Type	Integer
Parameter Range	1 ~ 16
Return	None
Default	None
Menu	Search > Domain > Delete
Example	:CALCulate1:MARKer:FUNcTion:DOMain:DELeTe 1

3.2.71 Select Search Range Number (:CALCulate{[1]-200}[:SElected]:MARKer:FUNcTion:DOMain:NUMb er)

Command Format	:CALCulate{[1]-200}[:SElected]:MARKer{[1]-10}:FUNcTion:DOMain:NUMb er <numeric> :CALCulate{[1]-200} [:SElected]:MARKer{[1]-10}:FUNcTion:DOMain:NUMb er? :CALCulate{[1]-200}:TRACe{[1]-200}:MARKer{[1]-10}:FUNcTion:DOMain:NUMb er <numeric> :CALCulate{[1]-200}:TRACe{[1]-200}:MARKer{[1]-10}:FUNcTion:DOMain:NUMb er?
Instruction	1. This command selects or gets search range number of search analysis for the selected marker, for the active trace of selected channel. 2. This command selects or gets search range number of search analysis for the selected marker, for the selected trace of selected channel.
Parameter Type	Integer
Parameter Range	1 ~ 16
Return	Integer
Default	None
Menu	Search > Domain
Example	:CALCulate1:TRACe1:MARKer1:FUNcTion:DOMain:NUMb er 3 :CALCulate1:TRACe1:MARKer1:FUNcTion:DOMain:NUMb er? Return: 3 :CALCulate1:MARKer:FUNcTion:DOMain:NUMb er 2 :CALCulate1:MARKer:FUNcTion:DOMain:NUMb er? Return: 2

3.2.72 Search Domain Start (:CALCulate{[1]-200}[:SElected]:MARKer:FUNcTion:DOMain{[1]-16}:STARt)

Command Format	:CALCulate{[1]-200}[:SElected]:MARKer:FUNcTion:DOMain{[1]-16}:STARt <numeric> :CALCulate{[1]-200}[:SElected]:MARKer:FUNcTion:DOMain{[1]-16}:STARt? :CALCulate{[1]-200}:TRACe{[1]-200}:MARKer:FUNcTion:DOMain{[1]-16}:STARt <numeric>
----------------	--

	:CALCulate{[1]-200}:TRACe{[1]-200}:MARKer:FUNcTion:DOMain{[1]-16}:STARt?
Instruction	This command sets/gets the start value of the marker search range, for the selected channel.
Parameter Type	Float
Parameter Range	9k~8.5GHz
Return	Float
Default	None
Menu	Search > Start
Example	:CALCulate1:MARKer:FUNcTion:DOMain2:STARt 1e9 :CALCulate1:MARKer:FUNcTion:DOMain2:STARt? Return: 1000000000 :CALCulate1:TRACe1:MARKer:FUNcTion:DOMain2:STARt 2e9 :CALCulate1:TRACe1:MARKer:FUNcTion:DOMain2:STARt? Return: 2000000000

3.2.73 Search Domain Stop (:CALCulate{[1]-200}[:SElected]:MARKer:FUNcTion:DOMain{[1]-16}:STOP)

Command Format	:CALCulate{[1]-200}[:SElected]:MARKer:FUNcTion:DOMain{[1]-16}:STOP <numeric> :CALCulate{[1]-200}[:SElected]:MARKer:FUNcTion:DOMain{[1]-16}:STOP? :CALCulate{[1]-200}:TRACe{[1]-200}:MARKer:FUNcTion:DOMain{[1]-16}:STOP <numeric> :CALCulate{[1]-200}:TRACe{[1]-200}:MARKer:FUNcTion:DOMain{[1]-16}:STOP?
Instruction	This command sets/gets the stop value of the marker search range, for the selected channel.
Parameter Type	Float
Parameter Range	9k~8.5GHz
Return	Float
Default	None
Menu	Search > Stop
Example	:CALCulate1:MARKer:FUNcTion:DOMain2:STOP 3e9 :CALCulate1:MARKer:FUNcTion:DOMain2:STOP? Return: 3000000000 :CALCulate1:TRACe1:MARKer:FUNcTion:DOMain2:STOP 4e9 :CALCulate1:TRACe1:MARKer:FUNcTion:DOMain2:STOP? Return: 4000000000

3.2.74 Execute Search (:CALCulate{[1]-200}[:SElected]:MARKer{[1]-10}:FUNcTion:EXECute)

Command Format	:CALCulate{[1]-200}[:SElected]:MARKer{[1]-10}:FUNcTion:EXECute :CALCulate{[1]-200}:TRACe{[1]-200}:MARKer{[1]-10}:FUNcTion:EXECute
Instruction	<ol style="list-style-type: none"> 1. This command immediately executes the specified search function of the active trace for the selected channel. 2. This command immediately executes the specified search function of the selected trace, for the selected channel.

Parameter Type	None
Parameter Range	None
Return	None
Default	None
Menu	Search > Max Search/Min Search Search > Peak Search/Peak Right Search/Peak Left Search Search > Target Search/Target Right Search/Target Left Search
Example	:CALCulate1:MARKer1:FUNcTion:TYPE MAXimum :CALCulate1:MARKer1:FUNcTion:EXECute :CALCulate1:TRACe1:MARKer1:FUNcTion:TYPE MINimum :CALCulate1:TRACe1:MARKer1:FUNcTion:EXECute

3.2.75 Tracking State (:CALCulate{[1]-200}[:SElected]:MARKer{[1]-10}:FUNcTion:TRACking)

Command Format	:CALCulate{[1]-200}[:SElected]:MARKer{[1]-10}:FUNcTion:TRACking {ON OFF 1 0} :CALCulate{[1]-200}[:SElected]:MARKer{[1]-10}:FUNcTion:TRACking? :CALCulate{[1]-200}:TRACe{[1]-200}:MARKer{[1]-10}:FUNcTion:TRACking {ON OFF 1 0} :CALCulate{[1]-200}:TRACe{[1]-200}:MARKer{[1]-10}:FUNcTion:TRACking?
Instruction	1. This command turns ON or OFF the tracking search capability for the specified marker of the active trace for the selected channel. 2. This command turns ON or OFF the tracking search capability for the specified marker of the selected trace, for the selected channel.
Parameter Type	Boolean
Parameter Range	ON OFF 1 0
Return	Boolean
Default	OFF
Menu	Search > Tracking
Example	:CALCulate1:MARKer2:FUNcTion:TRACking ON :CALCulate1:MARKer2:FUNcTion:TRACking? Return: 1 :CALCulate1:TRACe1:MARKer2:FUNcTion:TRACking OFF :CALCulate1:TRACe1:MARKer2:FUNcTion:TRACking? Return: 0

3.2.76 Peak Search Excursion (:CALCulate{[1]-200}[:SElected]:MARKer{[1]-10}:FUNcTion:PEXCursion)

Command Format	:CALCulate{[1]-200}[:SElected]:MARKer{[1]-10}:FUNcTion:PEXCursion <numeric> :CALCulate{[1]-200}[:SElected]:MARKer{[1]-10}:FUNcTion:PEXCursion? :CALCulate{[1]-200}:TRACe{[1]-200}:MARKer{[1]-10}:FUNcTion:PEXCursion <numeric> :CALCulate{[1]-200}:TRACe{[1]-200}:MARKer{[1]-10}:FUNcTion:PEXCursion?
Instruction	1. This command sets/gets the lower limit of peak excursion value when executing the peak search with marker 1 to 9 (Mk) and reference marker (Mk:10), for the active trace of selected channel (Ch). Peak excursion value is the mi

	<p>nimum value of the difference relative to the right and left adjacent measurement points.</p> <p>2. This command sets/gets the lower limit of peak excursion value when executing the peak search with marker 1 to 9 (Mk) and reference marker (Mk:10), for the selected trace of selected channel (Ch). Peak excursion value is the minimum value of the difference relative to the right and left adjacent measurement points.</p>
Parameter Type	Float
Parameter Range	-500dB~500dB
Return	Float
Default	3dB
Menu	Search > Peak > Excursion
Example	<pre>:CALCulate1:MARKer2:FUNCtion:PEXCursion 2 :CALCulate1:MARKer2:FUNCtion:PEXCursion? Return: 2 :CALCulate1:TRACe1:MARKer2:FUNCtion:PEXCursion 6 :CALCulate1:TRACe1:MARKer2:FUNCtion:PEXCursion? Return: 6</pre>

3.2.77 Peak Search POLarity (:CALCulate{[1]-200}[:SElected]:MARKer{[1]-10}:FUNCtion:PPOLarity)

Command Format	<pre>:CALCulate{[1]-200}[:SElected]:MARKer{[1]-10}:FUNCtion:PPOLarity {POSitive NEGative BOTH} :CALCulate{[1]-200}[:SElected]:MARKer{[1]-10}:FUNCtion:PPOLarity? :CALCulate{[1]-200}:TRACe{[1]-200}:MARKer{[1]-10}:FUNCtion:PPOLarity {POSitive NEGative BOTH} :CALCulate{[1]-200}:TRACe{[1]-200}:MARKer{[1]-10}:FUNCtion:PPOLarity?</pre>
Instruction	<ol style="list-style-type: none"> 1. This comamnd set/get the polarity of the peak search with marker 1 to 9 (Mk) and reference marker (Mk:10), for the active trace of selected channel (Ch). 2. This comamnd set/get the polarity of the peak search with marker 1 to 9 (Mk) and reference marker (Mk:10), for the selected trace of selected channel (Ch).
Parameter Type	Enumeration
Parameter Range	POSitive NEGative BOTH
Return	Enumeration
Default	POSitive
Menu	Search > Peak > Peak Polarity
Example	<pre>:CALCulate1:MARKer2:FUNCtion:PPOLarity NEGative :CALCulate1:MARKer2:FUNCtion:PPOLarity? Return: NEG :CALCulate1:TRACe1:MARKer2:FUNCtion:PPOLarity BOTH :CALCulate1:TRACe1:MARKer2:FUNCtion:PPOLarity? Return: BOTH</pre>

3.2.78 Peak Search THReshold (:CALCulate{[1]-200}[:SElected]:MARKer{[1]-10}:FUNCtion:THReshold)

Command Format	:CALCulate{[1]-200}:MEASure{[1]-200}:MARKer{[1]-10}:FUNction:PEAK:THReshold <numeric> :CALCulate{[1]-200}:MEASure{[1]-200}:MARKer{[1]-10}:FUNction:PEAK:THReshold?
Instruction	This comamnd set/get the threshold of the peak search with marker 1 to 9 (Mk) and reference marker (Mk:10), for the selected trace of selected channel (Ch).
Parameter Type	Float
Parameter Range	-500dB~500dB
Return	Float
Default	-100dB
Menu	Search > Peak > THReshold
Example	:CALCulate1:MEASure1:MARKer2:FUNction:PEAK:THReshold -20 :CALCulate1:MEASure1:MARKer2:FUNction:PEAK:THReshold? Return: -20

3.2.79 Target Search Value (:CALCulate{[1]-200}[:SELEcted]:MARKer{[1]-10}:FUNction:TARGet)

Command Format	:CALCulate{[1]-200}[:SELEcted]:MARKer{[1]-10}:FUNction:TARGet <numeric> :CALCulate{[1]-200}[:SELEcted]:MARKer{[1]-10}:FUNction:TARGet? :CALCulate{[1]-200}:TRACe{[1]-200}:MARKer{[1]-10}:FUNction:TARGet <numeric> :CALCulate{[1]-200}:TRACe{[1]-200}:MARKer{[1]-10}:FUNction:TARGet?
Instruction	1. This command sets/gets the target value to be searched with marker 1 to 9 (Mk) and reference marker (Mk:10), for the active trace of selected channel (Ch). 2. This command sets/gets the target value to be searched with marker 1 to 9 (Mk) and reference marker (Mk:10), for the selected trace of selected channel (Ch).
Parameter Type	Float
Parameter Range	-500dB~500dB
Return	Float
Default	0 dB
Menu	Search > Target > Target Value
Example	:CALCulate1:MARKer2:FUNction:TARGet 1 :CALCulate1:MARKer2:FUNction:TARGet? Return: 1 :CALCulate1:TRACe1:MARKer2:FUNction:TARGet -3 :CALCulate1:TRACe1:MARKer2:FUNction:TARGet? Return: -3

3.2.80 Transition Type of Target Search (:CALCulate{[1]-200}[:SELEcted]:MARKer{[1]-10}:FUNction:TTRansition)

Command Format	:CALCulate{[1]-200}[:SELEcted]:MARKer{[1]-10}:FUNction:TTRansition {POSitive NEGative BOTH} :CALCulate{[1]-200}[:SELEcted]:MARKer{[1]-10}:FUNction:TTRansition ? :CALCulate{[1]-200}:TRACe{[1]-200}:MARKer{[1]-10}:FUNction:TTRansition {P
----------------	--

	OSitive NEGative BOTH} :CALCulate{[1]-200}:TRACe{[1]-200}:MARKer{[1]-10}:FUNCTion:TTRansition ?
Instruction	<ol style="list-style-type: none"> 1. This command selects the transition type of the target search, for marker 1 to 9 (Mk) and reference marker (Mk:10) of the active trace of selected channel (Ch). 2. This command selects the transition type of the target search, for marker 1 to 9 (Mk) and reference marker (Mk:10) of the selected trace of selected channel (Ch).
Parameter Type	Enumeration
Parameter Range	POSitive NEGative BOTH
Return	Enumeration
Default	POSitive
Menu	Search > Target > TRansition
Example	<pre>:CALCulate1:MARKer2:FUNCTion:TTRansition NEGative :CALCulate1:MARKer2:FUNCTion:TTRansition? Return: NEG :CALCulate1:TRACe1:MARKer2:FUNCTion:TTRansition POSitive :CALCulate1:TRACe1:MARKer2:FUNCTion:TTRansition? Return: POS</pre>

3.2.81 Marker Search Type (:CALCulate{[1]-200}[:SElected]:MARKer{[1]-10}:FUNCTion:TYPE)

Command Format	:CALCulate{[1]-200}[:SElected]:MARKer{[1]-10}:FUNCTion:TYPE {MAXimum MINimum PEAK LPEak RPEak TARGet LTARget RTARget} :CALCulate{[1]-200}[:SElected]:MARKer{[1]-10}:FUNCTion:TYPE? :CALCulate{[1]-200}:TRACe{[1]-200}:MARKer{[1]-10}:FUNCTion:TYPE {MAXimum MINimum PEAK LPEak RPEak TARGet LTARget RTARget} :CALCulate{[1]-200}:TRACe{[1]-200}:MARKer{[1]-10}:FUNCTion:TYPE?
Instruction	<ol style="list-style-type: none"> 1. This command selects the search type for marker 1 to 9 (Mk) and reference marker (Mk:10), for the active trace of selected channel (Ch). 2. This command selects the search type for marker 1 to 9 (Mk) and reference marker (Mk:10), for the selected trace of selected channel (Ch).
Parameter Type	Enumeration
Parameter Range	MAXimum MINimum PEAK LPEak RPEak TARGet LTARget RTARget
Return	Enumeration
Default	None
Menu	Search > Max Search/Min Search Search > Peak Search/Peak Right Search/Peak Left Search Search > Target Search/Target Right Search/Target Left Search
Example	<pre>:CALCulate1:MARKer1:FUNCTion:TYPE RTARget :CALCulate1:MARKer1:FUNCTion:TYPE? Return: RTAR :CALCulate1:TRACe1:MARKer1:FUNCTion:TYPE PEAK :CALCulate1:TRACe1:MARKer1:FUNCTion:TYPE? Return: PEAK</pre>

3.2.82 Multi Peak Search Pexcurion (:CALCulate{[1]-200})

[:SElected]:MARKer:FUNcTion:MULTi:PEXCursion)

Command Format	:CALCulate{[1]-200}[:SElected]:MARKer:FUNcTion:MULTi:PEXCursion <numeric> :CALCulate{[1]-200}[:SElected]:MARKer:FUNcTion:MULTi:PEXCursion? :CALCulate{[1]-200}:TRACe{[1]-200}:MARKer:FUNcTion:MULTi:PEXCursion <numeric> :CALCulate{[1]-200}:TRACe{[1]-200}:MARKer:FUNcTion:MULTi:PEXCursion?
Instruction	<ol style="list-style-type: none"> 1. This command sets/gets the lower limit of multi peak excursion value when executing the peak search with marker 1 to 9 (Mk) and reference marker (Mk:10), for the active trace of selected channel (Ch). Peak excursion value is the minimum value of the difference relative to the right and left adjacent measurement points. 2. This command sets/gets the lower limit of multi peak excursion value when executing the peak search with marker 1 to 9 (Mk) and reference marker (Mk:10), for the selected trace of selected channel (Ch). Peak excursion value is the minimum value of the difference relative to the right and left adjacent measurement points.
Parameter Type	Float
Parameter Range	-500dB~500dB
Return	Float
Default	3 dB
Menu	Search > Multi Peak&Target > Peak Excursion
Example	:CALCulate1:MARKer:FUNcTion:MULTi:PEXCursion 2 :CALCulate1:MARKer:FUNcTion:MULTi:PEXCursion? Return: 2 :CALCulate1:TRACe1:MARKer:FUNcTion:MULTi:PEXCursion 6 :CALCulate1:TRACe1:MARKer:FUNcTion:MULTi:PEXCursion? Return: 6

3.2.83 Multi Peak Search POLarity (:CALCulate{[1]-200}[:SElected]:MARKer:FUNcTion:MULTi:PPOLarity)

Command Format	:CALCulate{[1]-200}[:SElected]:MARKer:FUNcTion:MULTi:PPOLarity {POSitive NEGative BOTH} :CALCulate{[1]-200}[:SElected]:MARKer:FUNcTion:MULTi:PPOLarity? :CALCulate{[1]-200}:TRACe{[1]-200}:MARKer:FUNcTion:MULTi:PPOLarity {POSitive NEGative BOTH} :CALCulate{[1]-200}:TRACe{[1]-200}:MARKer:FUNcTion:MULTi:PPOLarity?
Instruction	<ol style="list-style-type: none"> 1. This comamnd set/get the polarity of the multi peak search with marker 1 to 9 (Mk) and reference marker (Mk:10), for the active trace of selected channel (Ch). 2. This comamnd set/get the polarity of the multi peak search with marker 1 to 9 (Mk) and reference marker (Mk:10), for the selected trace of selected channel (Ch).
Parameter Type	Enumeration
Parameter Range	POSitive NEGative BOTH
Return	Enumeration
Default	POSitive

Menu	Search > Multi Peak& Target > Peak Polarity
Example	:CALCulate1:MARKer:FUNCTioN:MULTi:PPOLarity BOTH :CALCulate1:MARKer:FUNCTioN:MULTi:PPOLarity? Return: BOTH :CALCulate1:TRACe1:MARKer:FUNCTioN:MULTi:PPOLarity NEGative :CALCulate1:TRACe1:MARKer:FUNCTioN:MULTi:PPOLarity? Return: NEG

3.2.84 Multi Peak Search THReshold (:CALCulate{[1]-200}[:SELEcted]:MARKer:FUNCTioN:MULTi:THReshold)

Command Format	:CALCulate{[1]-200}[:SELEcted]:MARKer:FUNCTioN:MULTi:THReshold <numeric> :CALCulate{[1]-200}[:SELEcted]:MARKer:FUNCTioN:MULTi:THReshold? :CALCulate{[1]-200}:TRACe{[1]-200}:MARKer:FUNCTioN:MULTi:THReshold <numeric> :CALCulate{[1]-200}:TRACe{[1]-200}:MARKer:FUNCTioN:MULTi:THReshold?
Instruction	1. This comamnd set/get the threshold of the multi peak search with marker 1 to 9 (Mk) and reference marker (Mk:10), for the selected trace of active channel (Ch). 2. This comamnd set/get the threshold of the multi peak search with marker 1 to 9 (Mk) and reference marker (Mk:10), for the selected trace of selected channel (Ch).
Parameter Type	Float
Parameter Range	-500dB~500dB
Return	Float
Default	-100 dB
Menu	Search > Multi Peak&Target > Peak THReshold
Example	:CALCulate1:MARKer:FUNCTioN:MULTi:THReshold -20 :CALCulate1:MARKer:FUNCTioN:MULTi:THReshold? Return: -20 :CALCulate1:TRACe1:MARKer:FUNCTioN:MULTi:THReshold -30 :CALCulate1:TRACe1:MARKer:FUNCTioN:MULTi:THReshold? Return: -30

3.2.85 Multi Target Search Value (:CALCulate{[1]-200}[:SELEcted]:MARKer:FUNCTioN:MULTi:TARGet)

Command Format	:CALCulate{[1]-200}[:SELEcted]:MARKer:FUNCTioN:MULTi:TARGet <numeric> :CALCulate{[1]-200}[:SELEcted]:MARKer:FUNCTioN:MULTi:TARGet? :CALCulate{[1]-200}:TRACe{[1]-200}:MARKer:FUNCTioN:MULTi:TARGet <numeric> :CALCulate{[1]-200}:TRACe{[1]-200}:MARKer:FUNCTioN:MULTi:TARGet?
Instruction	1. This command sets/gets the multi target value to be searched with marker 1 to 9 (Mk) and reference marker (Mk:10), for the active trace of selected channel (Ch). 2. This command sets/gets the multi target value to be searched with marker 1 to 9 (Mk) and reference marker (Mk:10), for the selected trace of selected channel (Ch).

Parameter Type	Float
Parameter Range	-500dB~500dB
Return	Float
Default	0 dB
Menu	Search > Multi Peak&Target > Target Value
Example	:CALCulate1:MARKer:FUNCtion:MULTi:TARGet -10 :CALCulate1:MARKer:FUNCtion:MULTi:TARGet? Return: -10 :CALCulate1:TRACe1:MARKer:FUNCtion:MULTi:TARGet -5 :CALCulate1:TRACe1:MARKer:FUNCtion:MULTi:TARGet? Return: -5

3.2.86 Transition Type of Multi Target Search (:CALCulate{[1]-200}[:SElected]:MARKer:FUNCtion:TTRansition)

Command Format	:CALCulate{[1]-200}[:SElected]:MARKer:FUNCtion:MULTi:TTRansition {POSitive NEGative BOTH } :CALCulate{[1]-200}[:SElected]:MARKer:FUNCtion:MULTi:TTRansition ? :CALCulate{[1]-200}:TRACe{[1]-200}:MARKer:FUNCtion:MULTi:TTRansition {POSitive NEGative BOTH } :CALCulate{[1]-200}:TRACe{[1]-200}:MARKer:FUNCtion:MULTi:TTRansition ?
Instruction	1. This command selects the transition type of the multi target search, for marker 1 to 9 (Mk) and reference marker (Mk:10) of the active trace of selected channel (Ch). 2. This command selects the transition type of the multi target search, for marker 1 to 9 (Mk) and reference marker (Mk:10) of the selected trace of selected channel (Ch).
Parameter Type	Enumeration
Parameter Range	POSitive NEGative BOTH
Return	Enumeration
Default	POSitive
Menu	Search > Multi Peak&TTRansition > TTRansition
Example	:CALCulate1:MARKer:FUNCtion:MULTi:TTRansition NEGative :CALCulate1:MARKer:FUNCtion:MULTi:TTRansition? Return: NEG :CALCulate1:TRACe1:MARKer:FUNCtion:MULTi:TTRansition POSitive :CALCulate1:TRACe1:MARKer:FUNCtion:MULTi:TTRansition? Return: POS

3.2.87 Search Type of Multi Peak&Target Search(:CALCulate{[1]-200}[:SElected]:MARKer:FUNCtion:MULTi:TYPE)

Command Format	:CALCulate{[1]-200}[:SElected]:MARKer:FUNCtion:MULTi:TYPE {OFF PEAK TARGET} :CALCulate{[1]-200}[:SElected]:MARKer:FUNCtion:MULTi:TYPE?
----------------	---

	:CALCulate{[1]-200}:TRACe{[1]-200}:MARKer:FUNCTio:n:MULTi:TYPE {OFF P EAK TARGet} :CALCulate{[1]-200}:TRACe{[1]-200}:MARKer:FUNCTio:n:MULTi:TYPE?
Instruction	1. This command sets/gets the search type of the multi search of the active trace of selected channel (Ch). 2. This command sets/gets the search type of the multi search of the selected trace of selected channel (Ch).
Parameter Type	Enumeration
Parameter Range	PEAK TARGet OFF
Return	Enumeration
Default	None
Menu	None
Example	:CALCulate1:MARKer:FUNCTio:n:MULTi:TYPE PEAK :CALCulate1:MARKer:FUNCTio:n:MULTi:TYPE? Return: PEAK :CALCulate1:TRACe1:MARKer:FUNCTio:n:MULTi:TYPE TARGet :CALCulate1:TRACe1:MARKer:FUNCTio:n:MULTi:TYPE? Return: TARG

3.2.88 Notch Search State (:CALCulate{[1]-200}[:SElect ed]:MARKer{[1]-10}:NOTCh[:STATE])

Command Format	:CALCulate{[1]-200}[:SElect ed]:MARKer{[1]-10}:NOTCh[:STATE] {ON OFF 1 0} :CALCulate{[1]-200}[:SElect ed]:MARKer{[1]-10}:NOTCh[:STATE]? :CALCulate{[1]-200}:TRACe{[1]-200}:MARKer{[1]-10}:NOTCh[:STATE] {ON OFF 1 0} :CALCulate{[1]-200}:TRACe{[1]-200}:MARKer{[1]-10}:NOTCh[:STATE]?
Instruction	1. This command turns ON/OFF the notch search result display, for the active trace of selected channel (Ch). 2. This command turns ON/OFF the notch search result display, for the selected trace of selected channel (Ch).
Parameter Type	Boolean
Parameter Range	ON OFF 1 0
Return	Boolean
Default	OFF
Menu	Search > Notch > Notch Search Enable
Example	:CALCulate1:MARKer2:NOTCh ON :CALCulate1:MARKer2:NOTCh? Return: 1 :CALCulate1:TRACe1:MARKer2:NOTCh OFF :CALCulate1:TRACe1:MARKer2:NOTCh? Return: 0

3.2.89 Notch Search Level (:CALCulate{[1]-200}[:SElected]:MARKer{[1]-10}:NOTCh:THReshold)

Command Format	:CALCulate{[1]-200}[:SElected]:MARKer{[1]-10}:NOTCh:THReshold <numeric> :CALCulate{[1]-200}[:SElected]:MARKer{[1]-10}:NOTCh:THReshold?
----------------	---

	:CALCulate{[1]-200}:TRACe{[1]-200}:MARKer{[1]-10}:NOTCh:THReshold <numeric> :CALCulate{[1]-200}:TRACe{[1]-200}:MARKer{[1]-10}:NOTCh:THReshold?
Instruction	1. This command sets/gets the notch definition value of marker 1 to 9 (Mk) and reference marker (Mk:10), for the active trace of selected channel (Ch). 2. This command sets/gets the notch definition value of marker 1 to 9 (Mk) and reference marker (Mk:10), for the selected trace of selected channel (Ch).
Parameter Type	Float
Parameter Range	-500dB~500dB
Return	Float
Default	-3 dB
Menu	Search > Notch > Notch Level
Example	:CALCulate1:MARKer2:NOTCh:THReshold -6 :CALCulate1:MARKer2:NOTCh:THReshold? Return: -6 :CALCulate1:TRACe1:MARKer2:NOTCh:THReshold -3 :CALCulate1:TRACe1:MARKer2:NOTCh:THReshold? Return: -3

3.2.90 Get Notch Search Data (:CALCulate{[1]-200}[:SElected]:MARKer{[1]-10}:NOTCh:DATA?)

Command Format	:CALCulate{[1]-200}[:SElected]:MARKer{[1]-10}:NOTCh:DATA? :CALCulate{[1]-200}:TRACe{[1]-200}:MARKer{[1]-10}:NOTCh:DATA?
Instruction	This command reads the notch search result of marker 1 to 9 (Mk) and reference marker (Mk:10), for the active trace of selected channel (Ch). This command reads the notch search result of marker 1 to 9 (Mk) and reference marker (Mk:10), for the selected trace of selected channel (Ch).
Parameter Type	None
Parameter Range	None
Return	Indicates 4-element array data (notch bandwidth search result). <ul style="list-style-type: none"> ● Data(0) :The bandwidth. ● Data(1) :Center point frequency of the 2 cutoff frequency points. ● Data(2) :The Q value. ● Data(3) :Insertion loss The index of the array starts from 0.
Default	None
Menu	None
Example	:CALCulate1:MARKer2:NOTCh:DATA? :CALCulate1:TRACe1:MARKer2:NOTCh:DATA?

3.2.91 Math Method (:CALCulate{[1]-200}[:SElected]:MATH:FUNCTION)

Command Format	:CALCulate{[1]-200}[:SElected]:MATH:FUNCTION {NORMal SUBTract DIVide ADD MULTiply} :CALCulate{[1]-200}[:SElected]:MATH:FUNCTION? :CALCulate{[1]-200}:TRACe{[1]-200}:MATH:FUNCTION {NORMal SUBTract DIVide ADD MULTiply}
----------------	---

	:CALCulate{[1]-200}:TRACe{[1]-200}:MATH:FUNCTion?
Instruction	<ol style="list-style-type: none"> 1. This command sets/gets the data trace display method (math method between measurement data and memory trace data), for the active trace of selected channel (Ch). 2. This command sets/gets the data trace display method (math method between measurement data and memory trace data), for the selected trace of selected channel (Ch).
Parameter Type	Enumeration
Parameter Range	NORMal SUBTract DIVide ADD MULTiPLY
Return	Enumeration
Default	NORMal
Menu	Math > Memory > Math
Example	<pre>:CALCulate1:MATH:MEMorize :CALCulate1:MATH:FUNCTion SUBTract :CALCulate1:MATH:FUNCTion? Return: SUBT :CALCulate1:TRACe1:MATH:FUNCTion DIVide :CALCulate1:TRACe1:MATH:FUNCTion? Return: DIV</pre>

3.2.92 NORMALize (:CALCulate{[1]-200}[:SElected]:MATH:NORMALize)

Command Format	:CALCulate{[1]-200}[:SElected]:MATH:NORMAlize :CALCulate{[1]-200}:TRACe{[1]-200}:MATH:NORMAlize
Instruction	This command performs the same function as Data->Memory, then Data / Memory.
Parameter Type	None
Parameter Range	None
Return	None
Default	None
Menu	Math > Memory > Normalize
Example	<pre>:CALCulate1:MATH:NORMAlize :CALCulate1:TRACe1:MATH:NORMAlize</pre>

3.2.93 Data to Memory (:CALCulate{[1]-200}[:SElected]:MATH:MEMorize)

Command Format	:CALCulate{[1]-200}[:SElected]:MATH:MEMorize :CALCulate{[1]-200}:TRACe{[1]-200}:MATH:MEMorize
Instruction	This command puts the active data trace into memory. You can store one memory trace for every displayed trace.
Parameter Type	None
Parameter Range	None
Return	None
Default	None

Menu	Math > Memory > Data → Memory
Example	:CALCulate1:MATH:MEMorize :CALCulate1:TRACe1:MATH:MEMorize

3.2.94 Ripple Limit Test State (:CALCulate{[1]-200}[:SElected]:RLIMit[:STATe])

Command Format	:CALCulate{[1]-200}[:SElected]:RLIMit[:STATe] {ON OFF 1 0} :CALCulate{[1]-200}[:SElected]:RLIMit[:STATe]? :CALCulate{[1]-200}:TRACe{[1]-200}:RLIMit[:STATe] {ON OFF 1 0} :CALCulate{[1]-200}:TRACe{[1]-200}:RLIMit[:STATe]?
Instruction	1. This command turns ON/OFF the ripple test function for the active trace of selected channel. 2. This command turns ON/OFF the ripple test function for the selected trace of selected channel.
Parameter Type	Boolean
Parameter Range	ON OFF 1 0
Return	Boolean
Default	OFF
Menu	Math > Analysis > Limit > Ripple
Example	:CALCulate1:RLIMit ON :CALCulate1:RLIMit? Return: 1 :CALCulate1:TRACe1:RLIMit OFF :CALCulate1:TRACe1:RLIMit? Return: 0

3.2.95 Ripple Limit Test Sound State (:CALCulate{[1]-200}:MEASure{[1]-200}:RLIMit:SOUNd)

Command Format	:CALCulate{[1]-200}:MEASure{[1]-200}:RLIMit:SOUNd {ON OFF 1 0} :CALCulate{[1]-200}:MEASure{[1]-200}:RLIMit:SOUNd?
Instruction	This command gets/sets Ripple limit testing fail sound state.
Parameter Type	Boolean
Parameter Range	ON OFF 1 0
Return	Boolean
Default	OFF
Menu	Math > Analysis > Limit > Ripple
Example	:CALCulate1:MEASure1:RLIMit:SOUNd ON :CALCulate1:MEASure1:RLIMit:SOUNd? Return: 1

3.2.96 Ripple Limit Line State (:CALCulate{[1]-200}[:SElected]:RLIMit[:STATe])

Command Format	:CALCulate{[1]-200}[:SElected]:RLIMit:DISPlay:LINE {ON OFF 1 0} :CALCulate{[1]-200}[:SElected]:RLIMit:DISPlay:LINE?
----------------	--

	:CALCulate{[1]-200}:TRACe{[1]-200}:RLIMit:DISPlay:LINE {ON OFF 1 0} :CALCulate{[1]-200}:TRACe{[1]-200}:RLIMit:DISPlay:LINE?
Instruction	<ol style="list-style-type: none"> 1. This command turns ON/OFF the ripple limit line display, for the active trace of selected channel (Ch). 2. This command turns ON/OFF the ripple limit line display, for the selected trace of selected channel (Ch).
Parameter Type	Boolean
Parameter Range	ON OFF 1 0
Return	Boolean
Default	OFF
Menu	Math > Analysis > Limit > Ripple
Example	<pre>:CALCulate1:RLIMit:DISPlay:LINE ON :CALCulate1:RLIMit:DISPlay:LINE? Return: 1 :CALCulate1:TRACe1:RLIMit:DISPlay:LINE OFF :CALCulate1:TRACe1:RLIMit:DISPlay:LINE? Return: 0</pre>

3.2.97 Ripple Limit Data (:CALCulate{[1]-200}[:SElected]:RLIMit:DATA)

Command Format	:CALCulate{[1]-200}[:SElected]:RLIMit:DATA <String> :CALCulate{[1]-200}[:SElected]:RLIMit:DATA? :CALCulate{[1]-200}:TRACe{[1]-200}:RLIMit:DATA <String> :CALCulate{[1]-200}:TRACe{[1]-200}:RLIMit:DATA?
Instruction	<ol style="list-style-type: none"> 1. This command sets/gets the ripple limit table for the active trace of selected channel (Ch). 2. This command sets/gets the ripple limit table for the selected trace of selected channel (Ch).
Parameter Type	Data array
Parameter Range	<p>Indicates the array data (for ripple line) of 1 + Num (number of limit lines) \ 4. Where n is an integer between 1 and Num.</p> <ul style="list-style-type: none"> • Data(0) :The number of limit lines you want to set. Specify an integer ranging 0 to 12. When the number of limit lines is set to 0 (clears the limit table), the variable Data is only required with Data(0). • Data(nx4-3) :The type of the n-th line. Specify an integer 0 to 1 as follows. 0:UNUSED 1:ON 2:OFF • Data(nx4-2) :The value on the horizontal axis (frequency/power/time) of the start point of the n-th line. • Data(nx4-1) :The value on the horizontal axis (frequency/power/time) of the end point of the n-th line. • Data(nx4) :The ripple line value (dB) of the n-th line. <p>The index of the array starts from 0.</p>
Return	Data array
Default	None
Menu	Math > Analysis > Limit > Ripple

Example	<pre> :CALC1:RLIM:DATA 2,1,1E9,3E9,3,1,5E9,7E9,3 :CALC1:RLIM:DATA? Return: 2,1,1000000000,3000000000,3,1,5000000000,7000000000,3 :CALCulate1:TRACe1:RLIMit:DATA 2,1,1E9,2E9,3,0,5E9,6E9,-3 :CALCulate1:TRACe1:RLIMit:DATA? Return: 2,1,1000000000,2000000000,3,0,5000000000,6000000000,-3 </pre>
---------	---

3.2.98 Get Ripple Result (:CALCulate{[1]-200}[:SElected]:RLIMit:REPort[:DATA]?)

Command Format	<pre> :CALCulate{[1]-200}[:SElected]:RLIMit:REPort[:DATA]? :CALCulate{[1]-200}:TRACe{[1]-200}:RLIMit:REPort[:DATA]? </pre>
Instruction	<ol style="list-style-type: none"> This command reads the ripple value of the ripple test for the active trace of selected channel (Ch). This command reads the ripple value of the ripple test for the selected trace of selected channel (Ch).
Parameter Type	None
Parameter Range	None
Return	<p>Indicates the array data (for ripple line) of 1 + Num (number of limit lines)*3. Where n is an integer between 1 and 12.</p> <ul style="list-style-type: none"> Data(0): Number of ripple limit line. Data(nx3-2): Number of ripple limit bands. Data(nx3-1): Ripple value. Data(nx3): Results of ripple test. <p>Select from the following. 0: PASS 1: FAIL.</p> <p>The index of the array starts from 0.</p>
Default	0
Menu	Math > Analysis > Limit > Ripple
Example	<pre> :CALCulate1:RLIMit:REPort? :CALCulate1:TRACe1:RLIMit:REPort? </pre>

3.2.99 Ripple Limit Test Result (:CALCulate{[1]-200}[:SElected]:RLIMit:FAIL?)

Command Format	<pre> :CALCulate{[1]-200}[:SElected]:RLIMit:FAIL? :CALCulate{[1]-200}:TRACe{[1]-200}:RLIMit:FAIL? </pre>
Instruction	<ol style="list-style-type: none"> This command reads the ripple test result for the active trace of selected channel (Ch). This command reads the ripple test result for the selected trace of selected channel (Ch).
Parameter Type	None
Parameter Range	None
Return	1 0 1: Fail 0: Pass
Default	None

Menu	None
Example	:CALCulate1:RLIMit:FAIL? :CALCulate1:TRACe1:RLIMit:FAIL?

3.2.100 Smooth State (:CALCulate{[1]-200}[:SELEcted]:SMOothing[:STATe])

Command Format	:CALCulate{[1]-200}[:SELEcted]:SMOothing[:STATe] {ON OFF 1 0} :CALCulate{[1]-200}[:SELEcted]:SMOothing[:STATe]? :CALCulate{[1]-200}:TRACe{[1]-200}:SMOothing[:STATe] {ON OFF 1 0} :CALCulate{[1]-200}:TRACe{[1]-200}:SMOothing[:STATe]?
Instruction	1. This command turns ON/OFF the smoothing for the active trace of selected channel (Ch). 2. This command turns ON/OFF the smoothing for the selected trace of selected channel (Ch).
Parameter Type	Boolean
Parameter Range	ON OFF 1 0
Return	Boolean
Default	OFF
Menu	AVG BW > Smoothing > Smoothing
Example	:CALCulate1:SMOothing ON :CALCulate1:SMOothing? Return: 1 :CALCulate1:TRACe1:SMOothing OFF :CALCulate1:TRACe1:SMOothing? Return: 0

3.2.101 Smooth Aperture (:CALCulate{[1]-200}[:SELEcted]:SMOothing:APERture)

Command Format	:CALCulate{[1]-200}[:SELEcted]:SMOothing:APERture <numeric> :CALCulate{[1]-200}[:SELEcted]:SMOothing:APERture? :CALCulate{[1]-200}:TRACe{[1]-200}:SMOothing:APERture <numeric> :CALCulate{[1]-200}:TRACe{[1]-200}:SMOothing:APERture?
Instruction	1. This command sets/gets the smoothing aperture for the active trace of selected channel (Ch). 2. This command sets/gets the smoothing aperture for the selected trace of selected channel (Ch).
Parameter Type	float, unit %
Parameter Range	0~100
Return	Float, unit %
Default	2.49
Menu	AVG BW > Smoothing > Smoothing Percent
Example	:CALCulate1:SMOothing:APERture 14.43 :CALCulate1:SMOothing:APERture? Return: 14.4278606965174 :CALCulate1:TRACe1:SMOothing:APERture 20 :CALCulate1:TRACe1:SMOothing:APERture? Return: 19.4029850746269

3.2.102 Smooth Points (:CALCulate{[1]-200}:MEASure{[1]-200}:SMOothing:POINts)

Command Format	:CALCulate{[1]-200}:MEASure{[1]-200}:SMOothing:POINts <numeric> :CALCulate{[1]-200}:MEASure{[1]-200}:SMOothing:POINts?
Instruction	This command sets/gets the smoothing points for the active trace of selected channel (Ch).
Parameter Type	integer
Parameter Range	1~4999
Return	Integer
Default	5
Menu	AVG BW > Smoothing > Smoothing Points
Example	:CALCulate1:MEASure1:SMOothing:POINts 15 :CALCulate1:MEASure1:SMOothing:POINts? Return: 15

3.2.103 Reset Trace (:CALCulate{[1]-200}:TRACe{[1]-200}:HOLD:CLEar)

Command Format	:CALCulate{[1]-200}:TRACe{[1]-200}:HOLD:CLEar
Instruction	This command clears/resets the trace hold function that holds the active trace at either the maximum or minimum point.
Parameter Type	None
Parameter Range	None
Return	None
Default	None
Menu	Display > Trace Setup > Trace Hold > Restart
Example	:CALCulate1:TRACe1:HOLD:CLEar

3.2.104 Trace Hold Type (:CALCulate{[1]-200}:TRACe{[1]-200}:HOLD[:TYPE])

Command Format	:CALCulate{[1]-200}:TRACe{[1]-200}:HOLD[:TYPE] {OFF MAXimum MINimum} :CALCulate{[1]-200}:TRACe{[1]-200}:HOLD[:TYPE]?
Instruction	This command sets/gets maximum/minimum trace hold function to hold the active trace at the maximum or minimum point.
Parameter Type	Enumeration
Parameter Range	OFF MAXimum MINimum
Return	Enumeration
Default	OFF
Menu	Display > Trace Setup > Trace Hold
Example	:CALCulate1:TRACe1:HOLD MAXimum :CALCulate1:TRACe1:HOLD? Return: MAX

3.2.105 Impedance (Imaginary) of Port Z Conversion (:C

ALCulate{[1]-200}:FSIMulator:SENDEd:ZCONversion:PORT{[1]-4}:IMAGinary)

Command Format	:CALCulate{[1]-200}:FSIMulator:SENDEd:ZCONversion:PORT{[1]-4}:IMAGinary <numeric> :CALCulate{[1]-200}:FSIMulator:SENDEd:ZCONversion:PORT{[1]-4}:IMAGinary?
Instruction	This command sets/gets the impedance value (imaginary part) for the port impedance conversion function, for the ports of selected channel.
Parameter Type	Float, unit: ohm
Parameter Range	-1E+18 ~ 1E+18
Return	Float, unit: ohm
Default	0
Menu	Cal > Fixtures > Port Z Conversion > jX
Example	:CALCulate1:FSIMulator:SENDEd:ZCONversion:PORT1:IMAGinary 100 :CALCulate1:FSIMulator:SENDEd:ZCONversion:PORT1:IMAGinary? Return: 100

3.2.106 Impedance (Real) of Port Z Conversion (:CALCulate{[1]-200}:FSIMulator:SENDEd:ZCONversion:PORT{[1]-4}:REAL)

Command Format	:CALCulate{[1]-200}:FSIMulator:SENDEd:ZCONversion:PORT{[1]-4}:REAL <numeric> :CALCulate{[1]-200}:FSIMulator:SENDEd:ZCONversion:PORT{[1]-4}:REAL?
Instruction	This command sets/gets the impedance value (real part) for the port impedance conversion function, for the ports of selected channel.
Parameter Type	Float, unit: ohm
Parameter Range	0.001 to 1E7
Return	Float, unit: ohm
Default	50
Menu	Cal > Fixtures > Port Z Conversion > R
Example	:CALCulate1:FSIMulator:SENDEd:ZCONversion:PORT1:REAL 75 :CALCulate1:FSIMulator:SENDEd:ZCONversion:PORT1:REAL? Return: 75

3.2.107 Impedance of Port Z Conversion (:CALCulate{[1]-200}:FSIMulator:SENDEd:ZCONversion:PORT{[1]-4}:Z0[:R])

Command Format	:CALCulate{[1]-200}:FSIMulator:SENDEd:ZCONversion:PORT{[1]-4}:Z0[:R] <numeric> :CALCulate{[1]-200}:FSIMulator:SENDEd:ZCONversion:PORT{[1]-4}:Z0[:R]?
Instruction	This command sets/gets the impedance value for the port impedance conversion function, for the ports of selected channel.
Parameter Type	Float, unit: ohm
Parameter Range	0.001 to 1E7

Return	Float, unit: ohm
Default	50
Menu	Cal > Fixtures > Port Z Conversion > R
Example	:CALCulate1:FSIMulator:SENDEd:ZCONversion:PORT1:Z0 100 :CALCulate1:FSIMulator:SENDEd:ZCONversion:PORT1:Z0? Return: 100

3.2.108 State of Port Z Conversion (:CALCulate{[1]-200}:FSIMulator:SENDEd:ZCONversion:STATE)

Command Format	:CALCulate{[1]-200}:FSIMulator:SENDEd:ZCONversion:STATE {ON OFF 1 0} :CALCulate{[1]-200}:FSIMulator:SENDEd:ZCONversion:STATE?
Instruction	This command turns ON/OFF the port impedance conversion function when the fixture simulator function is ON, for all the ports of the selected channel.
Parameter Type	Boolean
Parameter Range	ON OFF 1 0
Return	Boolean
Default	OFF
Menu	Cal > Fixtures > Port Z Conversion
Example	:CALCulate1:FSIMulator:SENDEd:ZCONversion:STATE ON :CALCulate1:FSIMulator:SENDEd:ZCONversion:STATE? Return: 1

3.2.109 C Value of the Matching Circuit (:CALCulate{[1]-200}:FSIMulator:SENDEd:PMcircuit:PORT{[1]-4}:PARAMeters:C{[1]-2})

Command Format	:CALCulate{[1]-200}:FSIMulator:SENDEd:PMcircuit:PORT{[1]-4}:PARAMeters:C{[1]-2} <numeric> :CALCulate{[1]-200}:FSIMulator:SENDEd:PMcircuit:PORT{[1]-4}:PARAMeters:C{[1]-2}?
Instruction	This command sets/gets the C value of the matching circuit, for the ports of selected channel.
Parameter Type	Float, unit F (farad)
Parameter Range	None
Return	Float, unit F (farad)
Default	0
Menu	Cal > Fixtures > Port Matching > Circuit Model
Example	:CALCulate1:FSIMulator:SENDEd:PMcircuit:PORT1:PARAMeters:C 10e-9 :CALCulate1:FSIMulator:SENDEd:PMcircuit:PORT1:PARAMeters:C? Return: 1e-08

3.2.110 G Value of the Matching Circuit (:CALCulate{[1]-200}:FSIMulator:SENDEd:PMcircuit:PORT{[1]-4}:PARAMeters:G{[1]-2})

Command Format	:CALCulate{[1]-200}:FSIMulator:SENDEd:PMcircuit:PORT{[1]-4}:PARAMeters:
----------------	---

	G{[1]-2} <numeric> :CALCulate{[1]-200}:FSIMulator:SENDEd:PMCircuit:PORT{[1]-4}:PARAmeters: G{[1]-2}?
Instruction	This command sets/gets the G value of the matching circuit, for the ports of selected channel.
Parameter Type	Float, unit S (siemens)
Parameter Range	None
Return	Float, unit S (siemens)
Default	0
Menu	Cal > Fixtures > Port Matching > Circuit Model
Example	:CALCulate1:FSIMulator:SENDEd:PMCircuit:PORT1:PARAmeters:G1 10 :CALCulate1:FSIMulator:SENDEd:PMCircuit:PORT1:PARAmeters:G1? Return: 10

3.2.111 L Value of the Matching Circuit (:CALCulate{[1]-200}:FSIMulator:SENDEd:PMCircuit:PORT{[1]-4}:PARAmeters:L{[1]-2})

Command Format	:CALCulate{[1]-200}:FSIMulator:SENDEd:PMCircuit:PORT{[1]-4}:PARAmeters:L{[1]-2} <numeric> :CALCulate{[1]-200}:FSIMulator:SENDEd:PMCircuit:PORT{[1]-4}:PARAmeters:L{[1]-2}?
Instruction	This command sets/gets the L value of the matching circuit, for the ports of selected channel.
Parameter Type	Float, unit H (henry)
Parameter Range	None
Return	Float, unit H (henry)
Default	0
Menu	Cal > Fixtures > Port Matching > Circuit Model
Example	:CALCulate1:FSIMulator:SENDEd:PMCircuit:PORT1:PARAmeters:L1 5 :CALCulate1:FSIMulator:SENDEd:PMCircuit:PORT1:PARAmeters:L1? Return: 5

3.2.112 R Value of the Matching Circuit (:CALCulate{[1]-200}:FSIMulator:SENDEd:PMCircuit:PORT{[1]-4}:PARAmeters:R{[1]-2})

Command Format	:CALCulate{[1]-200}:FSIMulator:SENDEd:PMCircuit:PORT{[1]-4}:PARAmeters:R{[1]-2} <numeric> :CALCulate{[1]-200}:FSIMulator:SENDEd:PMCircuit:PORT{[1]-4}:PARAmeters:R{[1]-2}?
Instruction	This command sets/gets the R value of the matching circuit, for the ports of selected channel.
Parameter Type	Float, unit ohm
Parameter Range	None
Return	Float, unit ohm
Default	0
Menu	Cal > Fixtures > Port Matching > Circuit Model

Example	:CALCulate1:FSIMulator:SENDEd:PMCircuit:PORT1:PARAmeters:R2 25 :CALCulate1:FSIMulator:SENDEd:PMCircuit:PORT1:PARAmeters:R2? Return: 25
---------	--

3.2.113 Type of the Matching Circuit (:CALCulate{[1]-200}:FSIMulator:SENDEd:PMCircuit:PORT{[1]-4}:TYPE)

Command Format	:CALCulate{[1]-200}:FSIMulator:SENDEd:PMCircuit:PORT{[1]-4}:TYPE {NONE SLPC PCSL PLSC SCPL PLPC SCPC PCSC SLPL PLSL USER} :CALCulate{[1]-200}:FSIMulator:SENDEd:PMCircuit:PORT{[1]-4}:TYPE?
Instruction	This command sets/gets the type of the matching circuit, for the ports of selected channel.
Parameter Type	Enumeration
Parameter Range	<ul style="list-style-type: none"> ● "NONE": Specifies no-circuit. ● "SLPC": Specifies the circuit that consists of series L and shunt C. ● "PCSL": Specifies the circuit that consists of shunt C and series L. ● "PLSC": Specifies the circuit that consists of shunt L and series C. ● "SCPL": Specifies the circuit that consists of series C and shunt L. ● "PLPC": Specifies the circuit that consists of shunt L and shunt C. ● "SCPC": Specifies the circuit that consists of series C and shunt C. ● "PCSC": Specifies the circuit that consists of shunt C and series C. ● "SLPL": Specifies the circuit that consists of series L and shunt L. ● "PLSL": Specifies the circuit that consists of shunt L and series L. ● "USER": Specifies the user-defined circuit.
Return	Enumeration
Default	SLPC
Menu	Cal > Fixtures > Port Matching > Circuit Model
Example	:CALCulate1:FSIMulator:SENDEd:PMCircuit:PORT PLSL :CALCulate1:FSIMulator:SENDEd:PMCircuit:PORT1? Return: PLSL

3.2.114 Touchstone Filename for The Matching Circuit Model(:CALCulate{[1]-200}:FSIMulator:SENDEd:PMCircuit:PORT{[1]-4}:USER:FILENAME)

Command Format	:CALCulate{[1]-200}:FSIMulator:SENDEd:PMCircuit:PORT{[1]-4}:USER:FILENAME <string> :CALCulate{[1]-200}:FSIMulator:SENDEd:PMCircuit:PORT{[1]-4}:USER:FILENAME?
Instruction	This command sets/gets the file in which the information on the user-defined matching circuit is saved (2-port touchstone file), for the ports of selected channel.
Parameter Type	String
Parameter Range	None
Return	None
Default	None
Menu	Cal > Fixtures > Port Matching > Match S2P File
Example	:CALCulate1:FSIMulator:SENDEd:PMCircuit:PORT1:USER:FILENAME "local/test.s2p" :CALCulate1:FSIMulator:SENDEd:PMCircuit:PORT1:USER:FILENAME? Return: local/test.s2p

3.2.115 State of the Match Circuit Embedding Function (:CALCulate{[1]-200}:FSIMulator:SENDEd:PMCircuit:STATE)

Command Format	:CALCulate{[1]-200}:FSIMulator:SENDEd:PMCircuit:STATE {ON OFF 1 0} :CALCulate{[1]-200}:FSIMulator:SENDEd:PMCircuit:STATE?
Instruction	This command turns ON/OFF the matching circuit embedding function when the fixture simulator function is ON, for all the ports of selected channel.
Parameter Type	Boolean
Parameter Range	ON OFF 1 0
Return	Boolean
Default	OFF
Menu	Cal > Fixtures > Port Matching
Example	:CALCulate1:FSIMulator:SENDEd:PMCircuit:STATE ON :CALCulate1:FSIMulator:SENDEd:PMCircuit:STATE? Return: 1

3.2.116 State of the Network De-embedding Function (:CALCulate{[1]-200}:FSIMulator:SENDEd:DEEMbed:STATE)

Command Format	:CALCulate{[1]-200}:FSIMulator:SENDEd:DEEMbed:STATE {ON OFF 1 0} :CALCulate{[1]-200}:FSIMulator:SENDEd:DEEMbed:STATE?
Instruction	This command turns ON/OFF the network de-embedding function when the fixture simulator function is ON, for all the ports of selected channel.
Parameter Type	Boolean
Parameter Range	ON OFF 1 0
Return	Boolean
Default	OFF
Menu	Cal > Fixtures > 2 Port De-embedding
Example	:CALCulate1:FSIMulator:SENDEd:DEEMbed:STATE ON :CALCulate1:FSIMulator:SENDEd:DEEMbed:STATE? Return: 1

3.2.117 Touchstone Filename for the Network De-embedding Function(:CALCulate{[1]-200}:FSIMulator:SENDEd:DEEMbed:PORT{[1]-4}:USER:FILENAME)

Command Format	:CALCulate{[1]-200}:FSIMulator:SENDEd:DEEMbed:PORT{[1]-4}:USER:FILENAME <string> :CALCulate{[1]-200}:FSIMulator:SENDEd:DEEMbed:PORT{[1]-4}:USER:FILENAME?
Instruction	This command sets/gets the file in which the information on the user-defined network for the network de-embedding function is saved (2-port touchstone file), for the ports of selected channel.
Parameter Type	String
Parameter Range	None

Return	None
Default	None
Menu	Cal > Fixtures > 2 Port De-embedding > Select De-embedding
Example	:CALCulate1:FSIMulator:SENDEd:DEEMbed:PORT1:USER:FILEname "local/test.s2p" :CALCulate1:FSIMulator:SENDEd:DEEMbed:PORT1:USER:FILEname? Return: local/test.s2p

3.2.118 Typef of the Network De-embedding Function(:CALCulate{[1]-200}:FSIMulator:SENDEd:DEEMbed:PORT{[1]-4}[:TYPE])

Command Format	:CALCulate{[1]-200}:FSIMulator:SENDEd:DEEMbed:PORT{[1]-4}[:TYPE] {NONE USER} :CALCulate{[1]-200}:FSIMulator:SENDEd:DEEMbed:PORT{[1]-4}[:TYPE]?
Instruction	This command sets/gets the type of the network de-embedding function, for the ports of selected channel.
Parameter Type	Enumeration
Parameter Range	<ul style="list-style-type: none"> ● "NONE": Specifies no network de-embedding. ● "USER": Specifies the user-defined network de-embedding.
Return	Enumeration
Default	NONE
Menu	Cal > Fixtures > 2Port De-embedding > De-embedding Type
Example	:CALCulate1:FSIMulator:SENDEd:DEEMbed:PORT1 USER :CALCulate1:FSIMulator:SENDEd:DEEMbed:PORT1? Return: USER

3.2.119 State of the Reverse Adapter Ports (:CALCulate{[1]-200}:FSIMulator:SENDEd:DEEMbed:PORT{[1]-4}:SNP:REVerse)

Command Format	:CALCulate{[1]-200}:FSIMulator:SENDEd:DEEMbed:PORT{[1]-4}:SNP:REVerse {ON OFF 1 0} :CALCulate{[1]-200}:FSIMulator:SENDEd:DEEMbed:PORT{[1]-4}:SNP:REVerse?
Instruction	This command set and read whether or not to reverse ports on a 2-port fixture or adapter to be de-embedded.
Parameter Type	Boolean
Parameter Range	ON OFF 1 0
Return	Boolean
Default	OFF
Menu	Cal > Fixtures > 2 Port De-embedding > Reverse Adapter Ports
Example	:CALCulate1:FSIMulator:SENDEd:DEEMbed:PORT1:SNP:REVerse ON :CALCulate1:FSIMulator:SENDEd:DEEMbed:PORT1:SNP:REVerse? Return: 1

3.2.120 4 Port Touchstone Filename for the Network Embedding/De-embedding Feature(:CALCulate{[1]-200}:FSIMulator:EMBED:NETWork{[1]-4}:FILEname)

e)

Command Format	:CALCulate{[1]-200}:FSIMulator:EMBed:NETWork{[1]-4}:FILename <string> :CALCulate{[1]-200}:FSIMulator:EMBed:NETWork{[1]-4}:FILename?
Instruction	This command specifies a file in which the information of network (which you want to embed/de-embed using the 4-port network embedding/de-embedding feature) is saved for the selected channel. The file is saved as a 4-port touchstone file with the ".s4p" extension.
Parameter Type	String
Parameter Range	None
Return	None
Default	None
Menu	Cal > Fixtures > 4/6/8-Port Embed/De-embed
Example	:CALCulate1:FSIMulator:EMBed:NETWork1:FILename "local/test.s4p" :CALCulate1:FSIMulator:EMBed:NETWork1:FILename? Return: local/test.s4p

3.2.121 Processing Type of Network (:CALCulate{[1]-200}:FSIMulator:EMBed:NETWork{[1]-4}:TYPE)

Command Format	:CALCulate{[1]-200}:FSIMulator:EMBed:NETWork{[1]-4}:TYPE {NONE EMBed DEEMbed } :CALCulate{[1]-200}:FSIMulator:EMBed:NETWork{[1]-4}:TYPE?
Instruction	This command sets/gets the processing type for networks, for the 4-port network embedding/de-embedding feature for the selected channel.
Parameter Type	Enumeration
Parameter Range	<ul style="list-style-type: none"> ● "NONE": Specifies no-processing. ● "EMBed": Specifies embedding. ● "DEEMbed": Specifies de-embedding.
Return	Enumeration
Default	NONE
Menu	Cal > Fixtures > 4/6/8-Port Embed/De-embed
Example	:CALCulate1:FSIMulator:EMBed:NETWork1:TYPE DEEMbed :CALCulate1:FSIMulator:EMBed:NETWork1:TYPE? Return: DEEM

3.2.122 State of 4 Port Network Embedding/De-embedding Feature (:CALCulate{[1]-200}:FSIMulator:EMBed:STATE)

Command Format	:CALCulate{[1]-200}:FSIMulator:EMBed:STATe {ON OFF 1 0} :CALCulate{[1]-200}:FSIMulator:EMBed:STATe?
Instruction	This command turns ON/OFF the 4-port network embedding/de-embedding feature when the fixture simulator feature is ON, for the selected channel.
Parameter Type	Boolean
Parameter Range	ON OFF 1 0
Return	Boolean
Default	OFF
Menu	Cal > Fixtures > 4/6/8-Port Embed/De-embed

Example	:CALCulate1:FSIMulator:EMBed:STATe ON :CALCulate1:FSIMulator:EMBed:STATe? Return: 1
---------	---

3.2.123 Connection Mode of 4 Port Network Embedding/De-embedding Feature (:CALCulate{[1]-200}:FSIMulator:EMBed:TYPE)

Command Format	:CALCulate{[1]-200}:FSIMulator:EMBed:TYPE {A B C} :CALCulate{[1]-200}:FSIMulator:EMBed:TYPE?
Instruction	This command selects a connection type (Topology), for the 4-port network embedding/de-embedding feature for channels.
Parameter Type	Enumeration
Parameter Range	<ul style="list-style-type: none"> ● "A": Specifies connection type A. ● "B": Specifies connection type B. ● "C": Specifies connection type C.
Return	Enumeration
Default	A
Menu	Cal > Fixtures > 4/6/8-Port Embed/De-embed > Topology
Example	:CALCulate1:FSIMulator:EMBed:TYPE B :CALCulate1:FSIMulator:EMBed:TYPE? Return: B

3.2.124 Specifies Port Connections in Type A (:CALCulate{[1]-200}:FSIMulator:EMBed:TOPology:A:PORTs)

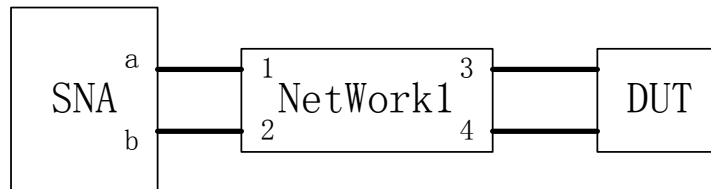

Command Format	:CALCulate{[1]-200}:FSIMulator:EMBed:TOPology:A:PORTs <numeric1>,<numeric 2> :CALCulate{[1]-200}:FSIMulator:EMBed:TOPology:A:PORTs?
Instruction	This command sets/gets the test port assignment when the connection type (Topology) is set to A, for the 4-port network embedding/de-embedding feature for selected channel.
Parameter Type	Data array
Parameter Range	<numeric1>: VNA Port number assigned to a in above graphic. <numeric2>: VNA Port number assigned to b in above graphic.
Return	Data array
Default	1,2
Menu	Cal > Fixtures > 4/6/8-Port Embed/De-embed
Example	:CALCulate1:FSIMulator:EMBed:TOPology:A:PORTs 2,1 :CALCulate1:FSIMulator:EMBed:TOPology:A:PORTs? Return: 2,1

3.2.125 Specifies Port Connections in Type B (:CALCulate{[1]-200}:FSIMulator:EMBed:TOPology:B:PORTs)

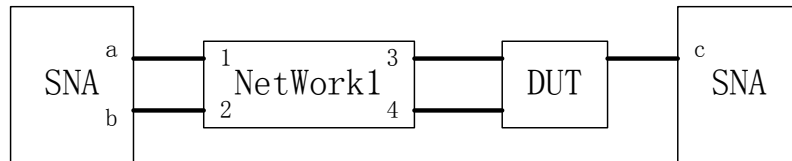

Command Format	:CALCulate{[1]-200}:FSIMulator:EMBed:TOPology:B:PORTs <numeric1>,<numeric2>,<numeric3> :CALCulate{[1]-200}:FSIMulator:EMBed:TOPology:B:PORTs?
Instruction	This command sets/gets test port assignment when the connection type (Topology) is set to B, for the 4-port network embedding/de-embedding feature for selected channel.
Parameter Type	Data array
Parameter Range	<numeric1>: VNA Port number assigned to a in above graphic. <numeric2>: VNA Port number assigned to b in above graphic. <numeric3>: VNA Port number assigned to c in above graphic.
Return	Data array
Default	1,2,3
Menu	Cal > Fixtures > 4/6/8-Port Embed/De-embed
Example	:CALCulate1:FSIMulator:EMBed:TOPology:B:PORTs 2,1,3 :CALCulate1:FSIMulator:EMBed:TOPology:B:PORTs? Return: 2,1,3

3.2.126 Specifies Port Connections in Type C (:CALCulate{[1]-200}:FSIMulator:EMBed:TOPology:C:PORTs)

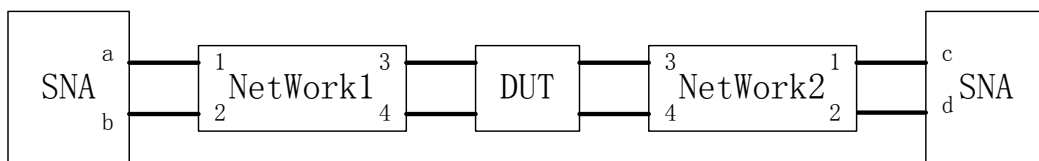

Command Format	:CALCulate{[1]-200}:FSIMulator:EMBed:TOPology:C:PORTs <numeric1>,<numeric2>,<numeric3>,<numeric4> :CALCulate{[1]-200}:FSIMulator:EMBed:TOPology:C:PORTs?
Instruction	This command sets/gets test port assignment when the connection type (Topology) is set to C, for the 4-port network embedding/de-embedding feature for selected channel.
Parameter Type	Data array
Parameter Range	<numeric1>: VNA Port number assigned to a in above graphic. <numeric2>: VNA Port number assigned to b in above graphic. <numeric3>: VNA Port number assigned to c in above graphic. <numeric4>: VNA Port number assigned to d in above graphic.
Return	Data array
Default	1,2,3,4
Menu	Cal > Fixtures > 4/6/8-Port Embed/De-embed
Example	:CALCulate1:FSIMulator:EMBed:TOPology:C:PORTs 2,1,3,4

	:CALCulate1:FSIMulator:EMBed:TOPology:C:PORTs? Return: 2,1,3,4
--	---

3.2.127 State of Fixture Simulator (:CALCulate{[1]-200}:FSIMulator:STATE)

Command Format	:CALCulate{[1]-200}:FSIMulator:STATE {ON OFF 1 0} :CALCulate{[1]-200}:FSIMulator:STATE?
Instruction	This command turns ON/OFF the fixture simulator function of selected channel.
Parameter Type	Boolean
Parameter Range	ON OFF 1 0
Return	Boolean
Default	OFF
Menu	Cal > Fixtures > Apply Fixtures
Example	:CALCulate1:FSIMulator:STATE ON :CALCulate1:FSIMulator:STATE? Return: 1

3.3 Display Subsystem

3.3.1 Set Active Channel (:DISPlay:WINDow{[1]-200}:ACTivate)

Command Format	:DISPlay:WINDow{[1]-200}:ACTivate
Instruction	This command specifies selected channel as the active channel.
Parameter Type	None
Parameter Range	None
Return	None
Default	1
Menu	Display > Channel Setup > Select
Example	:DISPlay:WINDow2:ACTivate

3.3.2 Active Window (:DISPlay:WINDow{[1]-200}:SELe ct)

Command Format	:DISPlay:WINDow{[1]-200}:SElect :DISPlay:WINDow:SElect?
Instruction	This command sets/gets the active window number.
Parameter Type	None
Parameter Range	None
Return	Integer
Default	1
Menu	Display > Window Setup > Select
Example	:DISPlay:WINDow2:SElect :DISPlay:WINDow:SElect? Return: 2

3.3.3 Window State (:DISPlay:WINDow{[1]-200}:STATe)

Command Format	:DISPlay:WINDow{[1]-200}:STATe {ON OFF 1 0} :DISPlay:WINDow{[1]-200}:STATe?
Instruction	This command sets/gets the display state of selected window.
Parameter Type	Boolean
Parameter Range	ON OFF 1 0
Return	Boolean
Default	None
Menu	None
Example	:DISPlay:WINDow4:STATe 1 :DISPlay:WINDow4:STATe? Return: 1

3.3.4 Move Trace to Window (DISPlay:MEASure{[1]-20

0}:MOVE)

Command Format	DISPlay:MEASure{[1]-200}:MOVE <numeric>
Instruction	Moves a trace associated with measurement number to the specified window.
Parameter Type	Integer
Parameter Range	1~200
Return	None
Default	None
Menu	Display > Trace Setup > Move Trace
Example	DISPlay:MEASure2:MOVE 4

3.3.5 Set Window Layout (:DISPlay:ARRange)

Command Format	:DISPlay:ARRange {TILE OVERlay STACK SPLIt QUAD MEASure CHANnel}
Instruction	Sets the layout of the windows on the LCD display.
Parameter Type	Enumeration
Parameter Range	TILE OVERlat STACK SPLIt QUAD MEASure CHANnel
Return	Enumeration
Default	OVERlat
Menu	Display > Window Setup > Window Layout
Example	:DISPlay:ARRange TILE

3.3.6 Active Window Maximization (:DISPlay:MAXimize)

Command Format	:DISPlay:MAXimize ON OFF 1 0 :DISPlay:MAXimize?
Instruction	This command turns ON/OFF the window maximization of the active channel. If the maximization is set to ON, only the window of the active channel is maximized on the LCD display and the windows of the other channels are not displayed.
Parameter Type	Boolean
Parameter Range	ON OFF 1 0
Return	Boolean
Default	1
Menu	Display > Window Setup > Window Max
Example	:DISPlay:MAXimize ON :DISPlay:MAXimize? Return: 1

3.3.7 Trace Display State (:DISPlay:WINDow{[1]-200}:TRACe{[1]-200})

Command Format	:DISPlay:WINDow{[1]-200}:TRACe{[1]-200} {ON OFF 1 0} :DISPlay:WINDow{[1]-200}:TRACe{[1]-200}?
----------------	--

Instruction	This command turns ON/OFF the trace display, for the selected trace of selected channel.
Parameter Type	Boolean
Parameter Range	ON OFF 1 0
Return	Boolean
Default	None
Menu	Display > Trace Setup > Add Trace / Delete Trace
Example	:DISPlay:WINDow1:TRACe5 1 :DISPlay:WINDow1:TRACe5? Return: 1

3.3.8 Data Trace Display State (:DISPlay:WINDow{[1]-200}:TRACe{[1]-200}:STATe)

Command Format	:DISPlay:WINDow{[1]-200}:TRACe{[1]-200}:STATe {ON OFF 1 0} :DISPlay:WINDow{[1]-200}:TRACe{[1]-200}:STATe?
Instruction	This command turns ON/OFF the data trace display, for the selected trace of selected channel.
Parameter Type	Boolean
Parameter Range	ON OFF 1 0
Return	Boolean
Default	None
Menu	Math > Display > Data (when the memory trace display is OFF) Math > Display > Data & Mem (when the memory trace display is ON)
Example	:DISPlay:WINDow1:TRACe5:STATe 0 :DISPlay:WINDow1:TRACe5:STATe? Return: 0

3.3.9 Memory Trace Display State (:DISPlay:WINDow{[1]-200}:TRACe{[1]-200}:MEMory[:STATe])

Command Format	:DISPlay:WINDow{[1]-200}:TRACe{[1]-200}:MEMory[:STATe] {ON OFF 1 0} :DISPlay:WINDow{[1]-200}:TRACe{[1]-200}:MEMory[:STATe]?
Instruction	This command turns ON/OFF the memory trace display, for the selected trace of selected channel.
Parameter Type	Boolean
Parameter Range	ON OFF 1 0
Return	Boolean
Default	None
Menu	Math > Display > Mem (when the data trace display is OFF) Math > Display > Data & Mem (when the data trace display is ON)
Example	:DISPlay:WINDow1:TRACe5:MEMory ON :DISPlay:WINDow1:TRACe5:MEMory? Return: 1

3.3.10 Active Trace Maximization (:DISPlay:WINDow{[1]

-200}:MAXimize)

Command Format	:DISPlay:WINDow{[1]-200}:MAXimize {ON OFF 1 0} :DISPlay:WINDow{[1]-200}:MAXimize?
Instruction	This command turns ON/OFF the maximization of the active trace of selected channel.
Parameter Type	Boolean
Parameter Range	ON OFF 1 0
Return	Boolean
Default	None
Menu	Display > Trace Setup > Trace Maximize
Example	:DISPlay:WINDow1:MAXimize 1 :DISPlay:WINDow1:MAXimize? Return: 1

3.3.11 Auto Scale (:DISPlay:WINDow{[1]-200}:TRACe{[1]-200}:Y[:SCALe]:AUTO)

Command Format	:DISPlay:WINDow{[1]-200}:TRACe{[1]-200}:Y[:SCALe]:AUTO
Instruction	This command executes the auto scale function, for the selected trace (Tr) of selected channel (Ch). The Auto Scale function automatically adjusts the value of the reference division line and the scale per division to display the trace appropriately.
Parameter Type	None
Parameter Range	None
Return	None
Default	None
Menu	Scale > Auto Scale
Example	:DISPlay:WINDow1:TRACe2:Y:AUTO

3.3.12 Auto Scale All (:DISPlay:WINDow{[1]-200}:Y:AUTO)

Command Format	:DISPlay:WINDow{[1]-200}:Y:AUTO
Instruction	Scales all of the traces to fit in the same window. This is equivalent to "Auto Scale All" from the front panel. Auto scale behaves differently when scale coupling is enabled. How it behaves depends on the scale coupling method.
Parameter Type	None
Parameter Range	None
Return	None
Default	None
Menu	Scale > Auto Scale All
Example	:DISPlay:WINDow1:Y:AUTO

3.3.13 Scale Per Division (:DISPlay:WINDow{[1]-200}:TRACe{[1]-200}:Y[:SCALE]:PDIVision)

Command Format	:DISPlay:WINDow{[1]-200}:TRACe{[1]-200}:Y[:SCALE]:PDIVision <numeric> :DISPlay:WINDow{[1]-200}:TRACe{[1]-200}:Y[:SCALE]:PDIVision?
Instruction	For the selected trace of selected channel, when the data format is not the Smith chart format or the polar format, sets the scale per division. When the data format is the Smith chart format or the polar format, sets the full scale value (the value of the outermost circumference).
Parameter Type	Float Unit varies depending on the data format. <ul style="list-style-type: none"> ● Log magnitude: dB (decibel) ● Phase, Expanded phase or Positive phase: ° (degree) ● Group delay: s (second) ● Others: No unit
Parameter Range	None
Return	Float
Default	Varies depending the data format. <ul style="list-style-type: none"> ● Log magnitude: 10 ● Phase, Expanded phase or Positive phase: 90 ● Group delay: 1E-8 ● Smith chart or Polar or SWR: 1 ● Linear magnitude: 0.1 ● Real or Imaginary: 0.2
Menu	Scale > Scale
Example	:DISPlay:WINDow1:TRACe1:Y:PDIVision 10 :DISPlay:WINDow1:TRACe1:Y:PDIVision? Return: 10

3.3.14 Scale Reference Level (:DISPlay:WINDow{[1]-200}:TRACe{[1]-200}:Y[:SCALE]:RLEVel)

Command Format	:DISPlay:WINDow{[1]-200}:TRACe{[1]-200}:Y[:SCALE]:RLEVel <numeric> :DISPlay:WINDow{[1]-200}:TRACe{[1]-200}:Y[:SCALE]:RLEVel?
Instruction	This command sets/gets the value of the reference division line, for the selected trace of selected channel.
Parameter Type	Float Unit varies depending on the data format. <ul style="list-style-type: none"> ● Log magnitude: dB (decibel) ● Phase, Expanded phase or Positive phase: ° (degree) ● Group delay: s (second) ● Others: No unit
Parameter Range	None
Return	Float
Default	0
Menu	Scale > Reference Level
Example	:DISPlay:WINDow1:TRACe1:Y:RLEVel 5 :DISPlay:WINDow1:TRACe1:Y:RLEVel? Return: 5

3.3.15 Scale Reference Position (:DISPlay:WINDow{[1]-

200}:TRACe{[1]-200}:Y[:SCALe]:RPOSition)

Command Format	:DISPlay:WINDow{[1]-200}:TRACe{[1]-200}:Y[:SCALe]:RPOSition <numeric> :DISPlay:WINDow{[1]-200}:TRACe{[1]-200}:Y[:SCALe]:RPOSition?
Instruction	This command specifies the position of a reference division line with its number (an integer assigned starting from 0 from the lowest division), for the selected trace of selected channel.
Parameter Type	Integer
Parameter Range	0 to the number of divisions
Return	Integer
Default	5
Menu	Scale > Reference Position
Example	:DISPlay:WINDow1:TRACe1:Y:RPOSition 6 :DISPlay:WINDow1:TRACe1:Y:RPOSition? Return: 6

3.3.16 Table Display Type (:DISPlay:WINDow{[1]-200}:TABLE)

Command Format	:DISPlay:WINDow{[1]-200}:TABLE {MARKer LIMit SEGMENT RLIMit OFF} :DISPlay:WINDow{[1]-200}:TABLE?
Instruction	This command selects the type of the window that appears in the lower part of the window display, for the selected window.
Parameter Type	Enumeration
Parameter Range	MARKer LIMit SEGMENT RLIMit OFF
Return	Enumeration
Default	OFF
Menu	Marker > Marker Table Math > Analysis > Limit Table > Limit Math > Analysis > Limit Table > Ripple Sweep > Segment Table > Show Table
Example	:DISPlay:WINDow2:TABLE RLIMit :DISPlay:WINDow2:TABLE? Return: RLIM

3.3.17 Global Fail Sign (:DISPlay:FSIGN)

Command Format	:DISPlay:FSIGN ON OFF 1 0 :DISPlay:FSIGN?
Instruction	Shows or hides the window which displays global pass/fail results.
Parameter Type	Boolean
Parameter Range	ON OFF 1 0
Return	Boolean
Default	OFF
Menu	Math> analysis> Global Pass/Fail ON
Example	:DISPlay:FSIGN 1 :DISPlay:FSIGN? Return: 1

3.3.18 Display Type of the Graph Horizontal Axis (:DISPlay:WINDow{[1]-200}:X:SPACing)

Command Format	:DISPlay:WINDow{[1]-200}:X:SPACing LINear OBASe :DISPlay:WINDow{[1]-200}:X:SPACing?
Instruction	This command selects the display type of the graph horizontal axis of selected channel for segment sweep.
Parameter Type	Enumeration
Parameter Range	Select from the following: <ul style="list-style-type: none"> • "LINear": Specifies the frequency base (linear frequency axis with the minimum frequency at the left edge and the maximum frequency at the right edge). • "OBASe" : Specifies the order base (axis in which the measurement point numbers are positioned evenly in the order of measurement).
Return	Enumeration
Default	LINear
Menu	Sweep > Segment Table > X-Axis Point Spacing
Example	:DISPlay:WINDow1:X:SPACing OBASe :DISPlay:WINDow1:X:SPACing? Return: OBAS

3.3.19 Clear Error Message (:DISPlay:CClear)

Command Format	:DISPlay:CClear
Instruction	This command clears the error message displayed in the status bar (at the bottom of the LCD display).
Parameter Type	None
Parameter Range	None
Return	None
Default	None
Menu	None
Example	:DISPlay:CClear

3.3.20 Display System Date and Time (:DISPlay:CLOCK)

Command Format	:DISPlay:CLOCK {ON OFF 1 0} :DISPlay:CLOCK?
Instruction	This command turns ON/OFF the clock display in the instrument status bar (at the right bottom of the LCD display).
Parameter Type	Boolean
Parameter Range	ON OFF 1 0
Return	Boolean
Default	1
Menu	System > Date&Time > Display Date Time

Example	:DISPlay:CLOCK OFF :DISPlay:CLOCK? Return: 0
---------	--

3.4 Sense Subsystem

3.4.1 Average Restart (:SENSe{[1]-200}:AVERAge:CLEAr)

Command Format	:SENSe{[1]-200}:AVERAge:CLEAr
Instruction	This command resets the data count to 0, used for averaging of selected channel. Measurement data before the execution of this object is not used for averaging.
Parameter Type	None
Parameter Range	None
Return	None
Default	None
Menu	AvgBW > Averaging Restart
Example	:SENSe1:AVERAge:CLEAr

3.4.2 Average Count (:SENSe{[1]-200}:AVERAge:COU Nt)

Command Format	:SENSe{[1]-200}:AVERAge:COUNT <numeric> :SENSe{[1]-200}:AVERAge:COUNT?
Instruction	This command sets/gets the averaging factor of selected channel.
Parameter Type	Integer
Parameter Range	2~999
Return	Integer
Default	16
Menu	AvgBW > Averaging
Example	:SENSe1:AVERAge:COUNT 10 :SENSe1:AVERAge:COUNT? Return: 10

3.4.3 State of Average (:SENSe{[1]-200}:AVERAge[:STATe])

Command Format	:SENSe{[1]-200}:AVERAge[:STATe] ON OFF 1 0 :SENSe{[1]-200}:AVERAge[:STATe]?
Instruction	This command sets/gets the averaging function of selected channel.
Parameter Type	Boolean
Parameter Range	ON OFF 1 0
Return	0 1
Default	0
Menu	AvgBW > Averaging Enable
Example	:SENSe1:AVERAge 1

	:SENSe1:AVERage? Return: 1
--	-------------------------------

3.4.4 IF Bandwidth (:SENSe{[1]-200}:BANDwidth[:RESolution])

Command Format	:SENSe{[1]-200}:BANDwidth[:RESolution] <numeric> :SENSe{[1]-200}:BANDwidth[:RESolution]?
Instruction	This command sets/gets the IF bandwidth of selected channel.
Parameter Type	Float, unit: Hz
Parameter Range	10Hz~3MHz
Return	Float, unit: Hz
Default	10 kHz
Menu	AvgBW > IF Bandwidth
Example	:SENSe1:BANDwidth 7e3 :SENSe1:BANDwidth? Return: 7000

3.4.5 IF Bandwidth (:SENSe{[1]-200}:BWIDth[:RESolution])

Command Format	:SENSe{[1]-200}:BWIDth[:RESolution] <numeric> :SENSe{[1]-200}:BWIDth[:RESolution]?
Instruction	This command sets/gets the IF bandwidth of selected channel.
Parameter Type	Float, unit:Hz
Parameter Range	10Hz~3MHz
Return	Float, unit:Hz
Default	10kHz
Menu	AvgBW > IF Bandwidth
Example	:SENSe1:BWIDth 15e3 :SENSe1:BWIDth? Return: 15000

3.4.6 Clear Error Coefficient (:SENSe{[1]-200}:CORRection:CLEAr)

Command Format	:SENSe{[1]-200}:CORRection:CLEAr
Instruction	This command clears the error coefficient for calibration of the select channel.
Parameter Type	None
Parameter Range	None
Return	None
Default	None
Menu	None
Example	:SENSe1:CORRection:CLEAr

3.4.7 Error Coefficient Data (:SENSe{[1]-200}:CORRection:COEFFicient[:DATA])

Command Format	:SENSe{[1]-200}:CORRection:COEFFicient[:DATA] {ES ER ED EL ET EX},<numeric 1>,<numeric 2>,<numeric 3>,...,<numeric 2+n*2> :SENSe{[1]-200}:CORRection:COEFFicient[:DATA]? {ES ER ED EL ET EX},<numeric 1>,<numeric 2>
Instruction	This command sets/gets the calibration coefficient data for specified channel.
Parameter Type	{ES ER ED EL ET EX}: error type <ul style="list-style-type: none"> ● “ES”: Source match ● “ER”: Reflection tracking ● “ED”: Directivity ● “EL”: Load match ● “ET”: Transmission tracking ● “EX”: Isolation <numeric 1>: Response port Integer. Range: 1~4 If ES, ER, or ED is used, the response port and the stimulus port must be the same, while EL, ET, or EX is used, the response port and the stimulus port must be different. <numeric 2>: Stimulus port Integer. Range: 1~4 <numeric 3>,...,<numeric 2+n*2>: error coefficient Indicates the array data (formatted data array) of NOP (number of measurement points)x2. Where n is an integer between 1 and NOP. Data(n×2-2): Data (primary value) at the n-th measurement point. Data(n×2-1): Data (secondary value) at the n-th measurement point. Always 0 when the data format is not the Smith chart format or the polar format. The index of the array starts from 0.
Parameter Range	None
Return	Indicates the array data (formatted data array) of NOP (number of measurement points)x2. Where n is an integer between 1 and NOP. Data(n×2-2): Data (primary value) at the n-th measurement point. Data(n×2-1): Data (secondary value) at the n-th measurement point. Always 0 when the data format is not the Smith chart format or the polar format. The index of the array starts from 0.
Default	None
Menu	None
Example	:SENSe1:CORRection:COEFFicient:MEtHod:THRU 2,1 :SENSe1:CORRection:COEFFicient ET,2,1,-1,0,-0.5,0,0.5,0 :SENSe1:CORRection:COEFFicient:SAVE :SENSe1:CORRection:COEFFicient? ET,2,1 Return: -1.000000000000e+00,0.000000000000e+00,-5.000000000000e-01,0.000000000000e+00,5.000000000000e-01,0.000000000000e+00

3.4.8 Import Enhanced Response Data(:SENSe{[1]-200}:CORRection:COEFFicient:MEtHod:ERESponse)

Command Format	:SENSe{[1]-200}:CORRection:COEFFicient:MEtHod:ERESponse <numeric 1>,<numeric 2>
----------------	---

Instruction	This command sets the calibration type to the enhanced response calibration between the two specified ports when the calibration coefficient data array is written with the SENSE(Ch):CORREction:COEFFicient:DATA command, for the selected channel.
Parameter Type	Array <numeric 1>: Specifies the response port. <numeric 2>: Specifies the stimulus port.
Parameter Range	1 ~ 4
Return	None
Default	None
Menu	None
Example	:SENSe1:CORREction:COEFFicient:METhod:ERESponse 1,2

3.4.9 Import Response(Open) Data(:SENSe{[1]-200}:CORREction:COEFFicient:METhod[:RESPonse]:OPEN)

Command Format	:SENSe{[1]-200}:CORREction:COEFFicient:METhod[:RESPonse]:OPEN <numeric>
Instruction	This command sets the calibration type to the response calibration (open) of the specified port when the calibration coefficient data array is written with the SENSE(Ch):CORREction:COEFFicient:DATA command, for the selected channel.
Parameter Type	Integer
Parameter Range	1~4
Return	None
Default	None
Menu	None
Example	:SENSe1:CORREction:COEFFicient:METhod:OPEN 1

3.4.10 Import Response(Short) Data(:SENSe{[1]-200}:CORREction:COEFFicient:METhod[:RESPonse]:SHORT)

Command Format	:SENSe{[1]-200}:CORREction:COEFFicient:METhod[:RESPonse]:SHORT <numeric>
Instruction	This command sets the calibration type to the response calibration (short) of the specified port when the calibration coefficient data array is written with the SENSE(Ch):CORREction:COEFFicient:DATA command, for the selected channel.
Parameter Type	Integer
Parameter Range	1~4
Return	None
Default	None
Menu	None
Example	:SENSe1:CORREction:COEFFicient:METhod:SHORT 1

3.4.11 Import Response(Thru) Data(:SENSe{[1]-200}:CO

RRection:COEFFicient:METhod[:RESPonse]:THR U)

Command Format	:SENSe{[1]-200}:CORRection:COEFFicient:METhod[:RESPonse]:THRU <numeric 1>,<numeric 2>
Instruction	This command sets the calibration type to the response calibration(thru) between the two specified ports when the calibration coefficient data array is written with the SENSe(Ch):CORRection:COEFFicient:DATA command, for the selected channel.
Parameter Type	Array <numeric 1>: Specifies the response port. <numeric 2>: Specifies the stimulus port.
Parameter Range	1~4
Return	None
Default	None
Menu	None
Example	:SENSe1:CORRection:COEFFicient:METhod:THRU 1,2

3.4.12 Import 1 Port SOLT Data(:SENSe{[1]-200}:CORRection:COEFFicient:METhod:SOLT1)

Command Format	:SENSe{[1]-200}:CORRection:COEFFicient:METhod:SOLT1 <numeric>
Instruction	This command sets the calibration type to the full 1-port calibration of the specified port, when the calibration coefficient data array is written with the SENSe(Ch):CORRection:COEFFicient:DATA command, for the selected channel.
Parameter Type	Integer
Parameter Range	1~4
Return	None
Default	None
Menu	None
Example	:SENSe1:CORRection:COEFFicient:METhod:SOLT1 1

3.4.13 Import 2 Port SOLT Data(:SENSe{[1]-200}:CORRection:COEFFicient:METhod:SOLT2)

Command Format	:SENSe{[1]-200}:CORRection:COEFFicient:METhod:SOLT2 <numeric1>,<numeric2>
Instruction	This command sets the calibration type to full 2-port calibration between the two specified ports, when the calibration coefficient data array is written with the SENSe(Ch):CORRection:COEFFicient:DATA command, for the selected channel.
Parameter Type	Array <numeric1>: Specifies a port for full 2-port calibration. <numeric2>: Specifies a port for full 2-port calibration.
Parameter Range	1~4
Return	None
Default	None
Menu	None
Example	:SENSe1:CORRection:COEFFicient:METhod:SOLT2 1,2

3.4.14 Import 3 Port SOLT Data(:SENSe{[1]-200}:CORRection:COEFFicient:METhod:SOLT3)

Command Format	:SENSe{[1]-200}:CORRection:COEFFicient:METhod:SOLT3 <numeric 1>,<numeric 2>,<numeric 3>
Instruction	This command sets the calibration type to full 3-port calibration between the three specified ports, when the calibration coefficient data array is written with the SENSe(Ch):CORRection:COEFFicient:DATA command, for the selected channel.
Parameter Type	Array <numeric 1>: Specifies a port for full 3-port calibration. <numeric 2>: Specifies a port for full 3-port calibration. <numeric 3>: Specifies a port for full 3-port calibration.
Parameter Range	1~4
Return	None
Default	None
Menu	None
Example	:SENSe1:CORRection:COEFFicient:METhod:SOLT3 1,2,4

3.4.15 Import 4 Port SOLT Data(:SENSe{[1]-200}:CORRection:COEFFicient:METhod:SOLT4)

Command Format	:SENSe{[1]-200}:CORRection:COEFFicient:METhod:SOLT4 <numeric 1>,<numeric 2>,<numeric 3>,<numeric 4>
Instruction	This command sets the calibration type to full 4-port calibration between the four specified ports, when the calibration coefficient data array is written with the SENSe(Ch):CORRection:COEFFicient:DATA command, for the selected channel.
Parameter Type	Array <numeric 1>: Specifies a port for full 4-port calibration. <numeric 2>: Specifies a port for full 4-port calibration. <numeric 3>: Specifies a port for full 4-port calibration. <numeric 4>: Specifies a port for full 4-port calibration.
Parameter Range	1~4
Return	None
Default	None
Menu	None
Example	:SENSe1:CORRection:COEFFicient:METhod:SOLT4 1,2,3,4

3.4.16 Save Error Coefficient Data(:SENSe{[1]-200}:CORRection:COEFFicient:SAVE)

Command Format	:SENSe{[1]-200}:CORRection:COEFFicient:SAVE
Instruction	This command enables the calibration coefficients depending on the selected calibration type from the writing calibration data. If you execute this command before all calibration data needed for calculating the calibration coefficients are written, an error occurs and the command is ignored.
Parameter Type	None

Parameter Range	None
Return	None
Default	None
Menu	None
Example	:SENSe1:CORRection:COEFficient:SAVE

3.4.17 Measure Isolation Calibration Data(:SENSe{[1]-200}:CORRection:COLLect[:ACQuire]:ISOLation)

Command Format	:SENSe{[1]-200}:CORRection:COLLect[:ACQuire]:ISOLation <numeric 1>,<numeric 2>
Instruction	This command measures the calibration data of the isolation from the specified stimulus port to the specified response port, for the selected channel.
Parameter Type	Array <numeric 1>: Specifies the response port number. <numeric 2>: Specifies the stimulus port number. If you specify the same port number to 2 port numbers, an error occurs when executed.
Parameter Range	1~4
Return	None
Default	None
Menu	Cal > Basic Cal > Response(Thru) > Isolation-Load(Optional) Cal > Basic Cal > Enhanced Response > Isolation-Load(Optional) Cal > Basic Cal > SOLT > Isolation-Load(Optional) Cal > Basic Cal > SOLR > Isolation-Load(Optional)
Example	:SENSe1:CORRection:COLLect:ISOLation 1,2

3.4.18 Measure Load Calibration Data(:SENSe{[1]-200}:CORRection:COLLect[:ACQuire]:LOAD)

Command Format	:SENSe{[1]-200}:CORRection:COLLect[:ACQuire]:LOAD <numeric>
Instruction	This command measures the calibration data of the load standard for the specified port, for the selected channel.
Parameter Type	Integer
Parameter Range	1~4
Return	None
Default	None
Menu	Cal > Basic Cal > Response(Open) > Load(Optional) Cal > Basic Cal > Response(Short) > Load(Optional) Cal > Basic Cal > OSL > Load Cal > Basic Cal > Enhanced Response > Load Cal > Basic Cal > SOLT > Load Cal > Basic Cal > SOLR > Load
Example	:SENSe1:CORRection:COLLect:LOAD 1

3.4.19 Measure Open Calibration Data(:SENSe{[1]-200}:CORRection:COLLect[:ACQuire]:OPEN)

Command Format	:SENSe{[1]-200}:CORRection:COLLect[:ACQuire]:OPEN <numeric>
Instruction	This command measures the calibration data of the OPEN standard for the specified port, for the selected channel.
Parameter Type	Integer
Parameter Range	1~4
Return	None
Default	None
Menu	Cal > Basic Cal > Response(Open) > Open Cal > Basic Cal > OSL > Open Cal > Basic Cal > Enhanced Response > Open Cal > Basic Cal > SOLT > Open Cal > Basic Cal > SOLR > Open
Example	:SENSe1:CORRection:COLLect:OPEN 1

3.4.20 Measure Short Calibration Data(:SENSe{[1]-200}:CORRection:COLLect[:ACQuire]:SHORT)

Command Format	:SENSe{[1]-200}:CORRection:COLLect[:ACQuire]:SHORT <numeric>
Instruction	This command measures the calibration data of the Short standard for the specified port, for the selected channel.
Parameter Type	Integer
Parameter Range	1~4
Return	None
Default	None
Menu	Cal > Basic Cal > Response(Short) > Short Cal > Basic Cal > OSL > Short Cal > Basic Cal > Enhanced Response > Short Cal > Basic Cal > SOLT > Short Cal > Basic Cal > SOLR > Short
Example	:SENSe1:CORRection:COLLect:SHORT 1

3.4.21 Measure Thru Calibration Data(:SENSe{[1]-200}:CORRection:COLLect[:ACQuire]:THRU)

Command Format	:SENSe{[1]-200}:CORRection:COLLect[:ACQuire]:THRU <numeric 1>,<numeric 2>
Instruction	This command measures the calibration data of the Thru standard from the specified stimulus port to the specified response port, for the selected channel.
Parameter Type	Array <numeric 1>: Specifies the response port number. <numeric 2>: Specifies the stimulus port number. If you specify the same port number to 2 port numbers, an error occurs when executed.
Parameter Range	1~4
Return	None
Default	None

Menu	Cal > Basic Cal > Response(Thru) > Thru Cal > Basic Cal > Enhanced Response > Thru Cal > Basic Cal > SOLT > Thru Cal > Basic Cal > SOLR > Unknown Thru
Example	:SENSe1:CORRection:COLLect:THRU 1,4

3.4.22 Measure TRL Calibration Line Data(:SENSe{[1]-200}:CORRection:COLLect[:ACQuire]:TRLLine)

Command Format	:SENSe{[1]-200}:CORRection:COLLect[:ACQuire]:TRLLine <numeric 1>,<numeric 2>
Instruction	This command executes LINE or MATCH measurement of the TRL calibration for the selected calibration kit, for the selected channel.
Parameter Type	Array <numeric 1>: Specifies the response port number. <numeric 2>: Specifies the stimulus port number. If you specify the same port number to 2 port numbers, an error occurs when executed.
Parameter Range	1~4
Return	None
Default	None
Menu	Cal > Basic Cal > TRL > Line
Example	:SENSe1:CORRection:COLLect:TRLLine 3,4

3.4.23 Measure TRL Calibration Reflect Data(:SENSe{[1]-200}:CORRection:COLLect[:ACQuire]:TRLReflect)

Command Format	:SENSe{[1]-200}:CORRection:COLLect[:ACQuire]:TRLReflect <numeric>
Instruction	This command executes the reflection measurement of the TRL calibration for the selected calibration kit, for the selected channel.
Parameter Type	Integer
Parameter Range	1~4
Return	None
Default	None
Menu	Cal > Basic Cal > TRL > Reflect
Example	:SENSe1:CORRection:COLLect:TRLReflect 1

3.4.24 Measure TRL Calibration Thru Data(:SENSe{[1]-200}:CORRection:COLLect[:ACQuire]:TRLThru)

Command Format	:SENSe{[1]-200}:CORRection:COLLect[:ACQuire]:TRLThru <numeric 1>,<numeric 2>
Instruction	This command executes THRU measurement of the TRL calibration for the selected calibration kit, for the selected channel.
Parameter Type	Array <numeric 1>: Specifies the response port number. <numeric 2>: Specifies the stimulus port number.

	If you specify the same port number to 2 port numbers, an error occurs when executed.
Parameter Range	1~4
Return	None
Default	None
Menu	Cal > Basic Cal > TRL > Thru
Example	:SENSe1:CORRection:COLLect:TRLThru 1,2

3.4.25 Label of Cal Kit (:SENSe{[1]-200}:CORRection:COLLect:CKIT:LABel)

Command Format	:SENSe{[1]-200}:CORRection:COLLect:CKIT:LABel <string> :SENSe{[1]-200}:CORRection:COLLect:CKIT:LABel?
Instruction	This command sets/gets the calibration kit name for the calibration kit selected, for selected channel.
Parameter Type	String
Parameter Range	None
Return	String
Default	None
Menu	Cal > Cal Kit > Edit > Cal Kit Name
Example	:SENSe1:CORRection:COLLect:CKIT:LABel "F503ME_1" :SENSe1:CORRection:COLLect:CKIT:LABel? Return: F503ME_1

3.4.26 Standart for Load Measurement (:SENSe:CORRection:COLLect:CKIT:ORDER:LOAD)

Command Format	:SENSe:CORRection:COLLect:CKIT:ORDER:LOAD <numeric1>{,<numeric 2>,...,<numeric n>} :SENSe:CORRection:COLLect:CKIT:ORDER:LOAD?
Instruction	This command sets/gets the standard(s) used for the load measurement for a calibration kit selected.
Parameter Type	Integer or array Specifies the order of standard.
Parameter Range	1~21
Return	Integer or array
Default	None
Menu	Cal > Cal Kit > Edit > SOLT > LOAD
Example	:SENSe:CORRection:COLLect:CKIT:ORDER:LOAD 2 :SENSe:CORRection:COLLect:CKIT:ORDER:LOAD? Return: 2

3.4.27 Standart for Open Measurement (:SENSe:CORRection:COLLect:CKIT:ORDER:OPEN)

Command Format	:SENSe:CORRection:COLLect:CKIT:ORDER:OPEN <numeric1>{,<numeric 2>,...,<numeric n>} :SENSe:CORRection:COLLect:CKIT:ORDER:OPEN?
----------------	--

Instruction	This command sets/gets the standard(s) used for the open measurement for a calibration kit selected.
Parameter Type	Integer or array Specifies the order of standard.
Parameter Range	1~21
Return	Integer or array
Default	None
Menu	Cal > Cal Kit > Edit > SOLT > OPEN
Example	:SENSe:CORRection:COLLect:CKIT:ORDer:OPEN 2,3 :SENSe:CORRection:COLLect:CKIT:ORDer:OPEN? Return: 2,3

3.4.28 Standart for Short Measurement (:SENSe:CORRection:COLLect:CKIT:ORDer:SHORT)

Command Format	:SENSe:CORRection:COLLect:CKIT:ORDer:SHORT <numeric1>{,<numeric 2>,....,<numeric n>} :SENSe:CORRection:COLLect:CKIT:ORDer:SHORT?
Instruction	This command sets/gets the standard(s) used for the short measurement, for a calibration kit selected.
Parameter Type	Integer or array Specifies the order of standard.
Parameter Range	1~21
Return	Integer or array
Default	None
Menu	Cal > Cal Kit > Edit > SOLT > SHORT
Example	:SENSe1:CORRection:COLLect:CKIT:ORDer:SHORT 3 :SENSe1:CORRection:COLLect:CKIT:ORDer:SHORT? Return: 3

3.4.29 Standart for Thru Measurement (:SENSe:CORRection:COLLect:CKIT:ORDer:THRU)

Command Format	:SENSe:CORRection:COLLect:CKIT:ORDer:THRU <numeric1>{,<numeric 2>,....,<numeric n>} :SENSe:CORRection:COLLect:CKIT:ORDer:THRU?
Instruction	This command sets/gets the standard(s) used for the thru measurement, for the calibration kit selected.
Parameter Type	Integer or array Specifies the order of standard.
Parameter Range	1~21
Return	Integer or array
Default	None
Menu	Cal > Cal Kit > Edit > SOLT > THRU
Example	:SENSe1:CORRection:COLLect:CKIT:ORDer:THRU 4,2 :SENSe1:CORRection:COLLect:CKIT:ORDer:THRU? Return: 4,2

3.4.30 Standart for TRL Line Measurement (:SENSe:CORRection:COLLect:CKIT:ORDer:TRLLine)

Command Format	:SENSe:CORRection:COLLect:CKIT:ORDer:TRLLine <numeric1>{,<numeric 2>,...,<numeric n>} :SENSe:CORRection:COLLect:CKIT:ORDer:TRLLine?
Instruction	This command sets/gets the standard used for the line measurement of TRL calibration, for the calibration kit selected.
Parameter Type	Integer or array Specifies the order of standard.
Parameter Range	1~21
Return	Integer or array
Default	None
Menu	Cal > Cal Kit > Edit > TRL > LINE/MATCH
Example	:SENSe1:CORRection:COLLect:CKIT:ORDer:TRLLine 2 :SENSe1:CORRection:COLLect:CKIT:ORDer:TRLLine? Return: 2

3.4.31 Standart for TRL Reflect Measurement(:SENSe:CORRection:COLLect:CKIT:ORDer:TRLReflect)

Command Format	:SENSe:CORRection:COLLect:CKIT:ORDer:TRLReflect <numeric1>{,<numeric 2>,...,<numeric n>} :SENSe:CORRection:COLLect:CKIT:ORDer:TRLReflect?
Instruction	This command sets/gets the standard used for the reflection measurement of the TRL calibration, for the calibration kit selected.
Parameter Type	Integer or array Specifies the order of standard.
Parameter Range	None
Return	Integer or array
Default	None
Menu	Cal > Cal Kit > Edit > TRL > REFLECT
Example	:SENSe1:CORRection:COLLect:CKIT:ORDer:TRLReflect 3 :SENSe1:CORRection:COLLect:CKIT:ORDer:TRLReflect? Return: 3

3.4.32 Standart for TRL Thru Measurement (:SENSe:CORRection:COLLect:CKIT:ORDer:TRLThru)

Command Format	:SENSe:CORRection:COLLect:CKIT:ORDer:TRLThru <numeric1>{,<numeric 2>,...,<numeric n>} :SENSe:CORRection:COLLect:CKIT:ORDer:TRLThru?
Instruction	This command sets/gets the standard used for the thru measurement of TRL calibration, for the calibration kit selected.
Parameter Type	Integer or array Specifies the order of standard.
Parameter Range	1~21
Return	Integer or array
Default	None
Menu	Cal > Cal Kit > Edit > TRL > THRU
Example	:SENSe1:CORRection:COLLect:CKIT:ORDer:TRLThru 3 :SENSe1:CORRection:COLLect:CKIT:ORDer:TRLThru? Return: 3

3.4.33 Reset Cal Kit (:SENSE:CORREction:COLLect:CKIT:RESet)

Command Format	:SENSE:CORREction:COLLect:CKIT:RESet
Instruction	This command resets the calibration kit selected to the default factory setting state.
Parameter Type	None
Parameter Range	None
Return	None
Default	None
Menu	None
Example	:SENSE:CORREction:COLLect:CKIT 2 :SENSE:CORREction:COLLect:CKIT:ORDer:OPEN 1,3 :SENSE:CORREction:COLLect:CKIT:RESet :SENSE:CORREction:COLLect:CKIT:ORDer:OPEN? Return: 2

3.4.34 Select Cal Kit (:SENSE:CORREction:COLLect:CKIT[:SElect])

Command Format	:SENSE:CORREction:COLLect:CKIT[:SElect] <numeric> :SENSE:CORREction:COLLect:CKIT[:SElect]?
Instruction	This command sets/gets the order of the selected calibration kit.
Parameter Type	Integer Specifies the order of standard.
Parameter Range	1~32
Return	Integer
Default	1
Menu	None
Example	:SENSE:CORREction:COLLect:CKIT 2 :SENSE:CORREction:COLLect:CKIT? Return: 2

3.4.35 C0 Value of the Standard (:SENSE:CORREction:COLLect:CKIT:STAN{[1]-30}:C0)

Command Format	:SENSE:CORREction:COLLect:CKIT:STAN{[1]-30}:C0 <numeric> :SENSE:CORREction:COLLect:CKIT:STAN{[1]-30}:C0?
Instruction	This command sets/gets the C0 value of the selected standard, for the calibration kit selected.
Parameter Type	Float Unit: fF (femto farad), 1E-15 F (farad)
Parameter Range	None
Return	Float Unit: fF (femto farad), 1E-15 F (farad)
Default	None

Menu	Cal > Cal Kit > Edit Kit > Standards > Edit > Open Characteristics > C0
Example	:SENSe:CORRection:COLLect:CKIT:STAN2:C0 100 :SENSe:CORRection:COLLect:CKIT:STAN2:C0? Return: 100

3.4.36 C1 Value of the Standard (:SENSe:CORRection:COLLect:CKIT:STAN{[1]-30}:C1)

Command Format	:SENSe:CORRection:COLLect:CKIT:STAN{[1]-30}:C1 <numeric> :SENSe:CORRection:COLLect:CKIT:STAN{[1]-30}:C1?
Instruction	This command sets/gets the C1 value of the selected standard, for the calibration kit selected.
Parameter Type	Float Unit: 1E-27 F/Hz (1E-27 farad / hertz)
Parameter Range	None
Return	Float Unit: 1E-27 F/Hz (1E-27 farad / hertz)
Default	None
Menu	Cal > Cal Kit > Edit Kit > Standards > Edit > Open Characteristics > C1
Example	:SENSe:CORRection:COLLect:CKIT:STAN2:C1 12.3 :SENSe:CORRection:COLLect:CKIT:STAN2:C1? Return: 12.3

3.4.37 C2 Value of the Standard (:SENSe:CORRection:COLLect:CKIT:STAN{[1]-30}:C2)

Command Format	:SENSe:CORRection:COLLect:CKIT:STAN{[1]-30}:C2 <numeric> :SENSe:CORRection:COLLect:CKIT:STAN{[1]-30}:C2?
Instruction	This command sets/gets the C2 value of the selected standard, for the calibration kit selected.
Parameter Type	Float Unit: 1E-36 F/Hz ² (1E-36 farad / hertz ²)
Parameter Range	None
Return	Float Unit: 1E-36 F/Hz ² (1E-36 farad / hertz ²)
Default	None
Menu	Cal > Cal Kit > Edit Kit > Standards > Edit > Open Characteristics > C2
Example	:SENSe:CORRection:COLLect:CKIT:STAN2:C2 25 :SENSe:CORRection:COLLect:CKIT:STAN2:C2? Return: 25

3.4.38 C3 Value of the Standard (:SENSe:CORRection:COLLect:CKIT:STAN{[1]-30}:C3)

Command Format	:SENSe:CORRection:COLLect:CKIT:STAN{[1]-30}:C3 <numeric> :SENSe:CORRection:COLLect:CKIT:STAN{[1]-30}:C3?
Instruction	This command sets/gets the C3 value of the selected standard, for the calibration kit selected.
Parameter Type	Float Unit: 1E-45 F/Hz ³ (1E-45 farad / hertz ³)

Parameter Range	None
Return	Float Unit: 1E-45 F/Hz ³ (1E-45 farad / hertz ³)
Default	None
Menu	Cal > Cal Kit > Edit Kit > Standards > Edit > Open Characteristics > C3
Example	:SENSe:CORRection:COLLect:CKIT:STAN2:C3 12.3 :SENSe:CORRection:COLLect:CKIT:STAN2:C3? Return: 12.3

3.4.39 L0 Value of the Standard (:SENSe:CORRection:COLLect:CKIT:STAN{[1]-30}:L0)

Command Format	:SENSe:CORRection:COLLect:CKIT:STAN{[1]-30}:L0 <numeric> :SENSe:CORRection:COLLect:CKIT:STAN{[1]-30}:L0?
Instruction	This command sets/gets the L0 value of the selected standard, for the calibration kit selected.
Parameter Type	Float Unit: pH (pico henry)
Parameter Range	None
Return	Float Unit: pH (pico henry)
Default	None
Menu	Cal > Cal Kit > Edit Kit > Standards > Edit > Short Characteristics > L0
Example	:SENSe:CORRection:COLLect:CKIT:STAN3:L0 10 :SENSe:CORRection:COLLect:CKIT:STAN3:L0? Return: 10

3.4.40 L1 Value of the Standard (:SENSe:CORRection:COLLect:CKIT:STAN{[1]-30}:L1)

Command Format	:SENSe:CORRection:COLLect:CKIT:STAN{[1]-30}:L1 <numeric> :SENSe:CORRection:COLLect:CKIT:STAN{[1]-30}:L1?
Instruction	This command sets/gets the L1 value of the selected standard, for the calibration kit selected.
Parameter Type	Float Unit: 1E-24 H/Hz (1E-24 henry / hertz)
Parameter Range	None
Return	Float Unit: 1E-24 H/Hz (1E-24 henry / hertz)
Default	None
Menu	Cal > Cal Kit > Edit Kit > Standards > Edit > Short Characteristics > L1
Example	:SENSe:CORRection:COLLect:CKIT:STAN3:L1 12.3 :SENSe:CORRection:COLLect:CKIT:STAN3:L1? Return: 12.3

3.4.41 L2 Value of the Standard (:SENSe:CORRection:COLLect:CKIT:STAN{[1]-30}:L2)

Command Format	:SENSe:CORRection:COLLect:CKIT:STAN{[1]-30}:L2 <numeric> :SENSe:CORRection:COLLect:CKIT:STAN{[1]-30}:L2?
----------------	---

Instruction	This command sets/gets the L2 value of the selected standard, for the calibration kit selected.
Parameter Type	Float Unit: 1E-33 H/Hz ² (1E-33 henry / hertz ²)
Parameter Range	None
Return	Float Unit: 1E-33 H/Hz ² (1E-33 henry / hertz ²)
Default	None
Menu	Cal > Cal Kit > Edit Kit > Standards > Edit > Short Characteristics > L2
Example	:SENSe:CORRection:COLLect:CKIT:STAN3:L2 12.3 :SENSe:CORRection:COLLect:CKIT:STAN3:L2? Return: 12.3

3.4.42 L3 Value of the Standard (:SENSe:CORRection:COLLect:CKIT:STAN{[1]-30}:L3)

Command Format	:SENSe:CORRection:COLLect:CKIT:STAN{[1]-30}:L3 <numeric> :SENSe:CORRection:COLLect:CKIT:STAN{[1]-30}:L3?
Instruction	This command sets/gets the L3 value of the selected standard, for the calibration kit selected.
Parameter Type	Float Unit: 1E-42 H/Hz ³ (1E-42 henry / hertz ³)
Parameter Range	None
Return	Float Unit: 1E-42 H/Hz ³ (1E-42 henry / hertz ³)
Default	None
Menu	Cal > Cal Kit > Edit Kit > Standards > Edit > Short Characteristics > L3
Example	:SENSe:CORRection:COLLect:CKIT:STAN3:L3 12.3 :SENSe:CORRection:COLLect:CKIT:STAN3:L3? Return: 12.3

3.4.43 Delay of the Standard (:SENSe:CORRection:COLLect:CKIT:STAN{[1]-30}:DELay)

Command Format	:SENSe:CORRection:COLLect:CKIT:STAN{[1]-30}:DELay <numeric> :SENSe:CORRection:COLLect:CKIT:STAN{[1]-30}:DELay?
Instruction	This command sets/gets the value of the offset delay of the selected standard, for the calibration kit selected.
Parameter Type	Float Unit: s (second)
Parameter Range	None
Return	Float Unit: s (second)
Default	None
Menu	Cal > Cal Kit > Edit Kit > Standards > Edit > Delay Characteristics > Delay
Example	:SENSe:CORRection:COLLect:CKIT:STAN1:DELay 1 :SENSe:CORRection:COLLect:CKIT:STAN1:DELay? Return: 1

3.4.44 Max Frequency of the Standard (:SENSe:CORRection:COLLect:CKIT:STAN{[1]-30}:FMAXimum)

Command Format	:SENSe:CORRection:COLLect:CKIT:STAN{[1]-30}:FMAXimum <numeric> :SENSe:CORRection:COLLect:CKIT:STAN{[1]-30}:FMAXimum?
Instruction	This command sets/gets the value of the stop frequency of the selected standard, for the calibration kit selected.
Parameter Type	Float Unit: Hz (hertz)
Parameter Range	None
Return	Float Unit: Hz (hertz)
Default	None
Menu	Cal > Cal Kit > Edit Kit > Standards > Edit > Frequency Range > Max
Example	:SENSe:CORRection:COLLect:CKIT:STAN1:FMAXimum 4.5e9 :SENSe:CORRection:COLLect:CKIT:STAN1:FMAXimum? Return: 4500000000

3.4.45 Min Frequency of the Standard (:SENSe:CORRection:COLLect:CKIT:STAN{[1]-30}:FMINimum)

Command Format	:SENSe:CORRection:COLLect:CKIT:STAN{[1]-30}:FMINimum <numeric> :SENSe:CORRection:COLLect:CKIT:STAN{[1]-30}:FMINimum?
Instruction	This command sets/gets the value of the start frequency of the selected standard, for the calibration kit selected.
Parameter Type	Float Unit: Hz (hertz)
Parameter Range	None
Return	Float Unit: Hz (hertz)
Default	None
Menu	Cal > Cal Kit > Edit Kit > Standards > Edit > Frequency Range > MIN
Example	:SENSe:CORRection:COLLect:CKIT:STAN1:FMINimum 500e6 :SENSe:CORRection:COLLect:CKIT:STAN1:FMINimum? Return: 500000000

3.4.46 Label of Cal Standard (:SENSe:CORRection:COLLect:CKIT:STAN{[1]-30}:LABEL)

Command Format	:SENSe:CORRection:COLLect:CKIT:STAN{[1]-30}:LABEL <string> :SENSe:CORRection:COLLect:CKIT:STAN{[1]-30}:LABEL?
Instruction	This command sets/gets the name of the selected standard, for the calibration kit selected.
Parameter Type	String
Parameter Range	None
Return	String
Default	None
Menu	Cal > Cal Kit > Edit Kit > Standards > Edit > Label
Example	:SENSe:CORRection:COLLect:CKIT:STAN1:LABEL "LOAD_1"

	:SENSe:CORRection:COLLect:CKIT:STAN1:LABel? Return: LOAD_1
--	---

3.4.47 Loss of the Standard (:SENSe:CORRection:COLLect:CKIT:STAN{[1]-30}:LOSS)

Command Format	:SENSe:CORRection:COLLect:CKIT:STAN{[1]-30}:LOSS <numeric> :SENSe:CORRection:COLLect:CKIT:STAN{[1]-30}:LOSS?
Instruction	This command sets/gets the value of the loss of the selected standard, for the calibration kit selected.
Parameter Type	Float Unit: ohm/s
Parameter Range	None
Return	Float Unit: ohm/s
Default	None
Menu	Cal > Cal Kit > Edit Kit > Standards > Edit > Delay Characteristics > Loss
Example	:SENSe:CORRection:COLLect:CKIT:STAN1:LOSS 0.5 :SENSe:CORRection:COLLect:CKIT:STAN1:LOSS? Return: 0.5

3.4.48 Z0 of the Standard (:SENSe:CORRection:COLLect:CKIT:STAN{[1]-30}:Z0)

Command Format	:SENSe:CORRection:COLLect:CKIT:STAN{[1]-30}:Z0 <numeric> :SENSe:CORRection:COLLect:CKIT:STAN{[1]-30}:Z0?
Instruction	This command sets/gets the value of the offset Z0 of the selected standard, for the calibration kit selected.
Parameter Type	Float Unit: ohm
Parameter Range	None
Return	Float Unit: ohm
Default	None
Menu	Cal > Cal Kit > Edit Kit > Standards > Edit > Delay Characteristics > Z0
Example	:SENSe:CORRection:COLLect:CKIT:STAN1:Z0 75 :SENSe:CORRection:COLLect:CKIT:STAN1:Z0? Return: 75

3.4.49 Standard Type (:SENSe:CORRection:COLLect:CKIT:STAN{[1]-30}:TYPE)

Command Format	:SENSe:CORRection:COLLect:CKIT:STAN{[1]-30}:TYPE <numeric> :SENSe:CORRection:COLLect:CKIT:STAN{[1]-30}:TYPE?
Instruction	This command sets/gets the standard type for the calibration kit selected.
Parameter Type	Enumeration
Parameter Range	OPEN SHORT LOAD THRU
Return	Enumeration

Default	OPEN
Menu	Cal > Cal Kit > Edit Kit > Standards > Add > Add Standard
Example	:SENSe:CORRection:COLLect:CKIT:STAN1:TYPE LOAD :SENSe:CORRection:COLLect:CKIT:STAN1:TYPE? Return: LOAD

3.4.50 TRL Reference Impedance (:SENSe:CORRection:COLLect:CKIT:TRLOption:IMPedance)

Command Format	:SENSe:CORRection:COLLect:CKIT:TRLOption:IMPedance {LINE SYSTem} :SENSe:CORRection:COLLect:CKIT:TRLOption:IMPedance?
Instruction	This command sets/gets the reference impedance during the TRL calibration.
Parameter Type	Enumeration
Parameter Range	LINE SYSTem
Return	Enumeration
Default	SYSTem
Menu	Cal > Cal Kit > Edit Kit > TRL > Calibration Reference Z0
Example	:SENSe:CORRection:COLLect:CKIT:TRLOption:IMPedance LINE :SENSe:CORRection:COLLect:CKIT:TRLOption:IMPedance? Return: LINE

3.4.51 TRL Calibration Plane (:SENSe:CORRection:COLLect:CKIT:TRLOption:RPLane)

Command Format	:SENSe:CORRection:COLLect:CKIT:TRLOption:RPLane {THRU REFLect} :SENSe:CORRection:COLLect:CKIT:TRLOption:RPLane?
Instruction	This command sets/gets the reference plane during the TRL calibration.
Parameter Type	Enumeration
Parameter Range	THRU REFLect
Return	Enumeration
Default	THRU
Menu	Cal > Cal Kit > Edit Kit > TRL > Test Port reference Plane
Example	:SENSe:CORRection:COLLect:CKIT:TRLOption:RPLane REFLect :SENSe:CORRection:COLLect:CKIT:TRLOption:RPLane? Return: REFL

3.4.52 Cancel the Calibration Measurement (:SENSe{[1]-200}:CORRection:COLLect:CLEar)

Command Format	:SENSe{[1]-200}:CORRection:COLLect:CLEar
Instruction	This command clears the calibration measurement data when the frequency off set feature is off, for the selected channel.
Parameter Type	None
Parameter Range	None
Return	None

Default	None
Menu	Cal > Basic Cal > Cancel Cal > Basic Cal > Next > Cancel
Example	:SENSe1:CORRection:COLLect:CLEar

3.4.53 Set Calibration Type to Enhanced Response (:SENSe{[1]-200}:CORRection:COLLect:METHod:ERESponse)

Command Format	:SENSe{[1]-200}:CORRection:COLLect:METHod:ERESponse <numeric 1>,<numeric 2>
Instruction	This command sets the calibration type to the enhanced response calibration between the two specified ports, for the selected channel.
Parameter Type	Array <numeric 1>: Specifies the response port number. <numeric 2>: Specifies the stimulus port number.
Parameter Range	1~4
Return	None
Default	None
Menu	Cal > Basic Cal > Enhanced Response
Example	:SENSe1:CORRection:COLLect:METHod:ERESponse 1,2

3.4.54 Set Calibration Type to Response(Open) (:SENSe{[1]-200}:CORRection:COLLect:METHod[:RESPonse]:OPEN)

Command Format	:SENSe{[1]-200}:CORRection:COLLect:METHod[:RESPonse]:OPEN <numeric>
Instruction	This command sets the calibration type to the response calibration (open) of the specified port, for the selected channel.
Parameter Type	Integer
Parameter Range	1 to 4
Return	None
Default	None
Menu	Cal > Basic Cal > Response(Open)
Example	:SENSe1:CORRection:COLLect:METHod:OPEN 2

3.4.55 Set Calibration Type to Response(Short) (:SENSe{[1]-200}:CORRection:COLLect:METHod[:RESPonse]:SHORT)

Command Format	:SENSe{[1]-200}:CORRection:COLLect:METHod[:RESPonse]:SHORT <numeric>
Instruction	This command sets the calibration type to the response calibration (short) of the specified port, for the selected channel.
Parameter Type	Integer

Parameter Range	1 to 4
Return	None
Default	None
Menu	Cal > Basic Cal > Response(Short)
Example	:SENSe1:CORRection:COLLect:METHod:SHORt 3

3.4.56 Set Calibration Type to Response(Thru) (:SENSe{[1]-200}:CORRection:COLLect:METHod[:RESPonse]:THRU)

Command Format	:SENSe{[1]-200}:CORRection:COLLect:METHod[:RESPonse]:THRU <numeric 1>,<numeric 2>
Instruction	This command sets the calibration type to the response calibration (thru) between the specified 2 ports, for the selected channel.
Parameter Type	Array <numeric 1>: Specifies the response port number. <numeric 2>: Specifies the stimulus port number.
Parameter Range	1~4
Return	None
Default	None
Menu	Cal > Basic Cal > Response(Thru)
Example	:SENSe1:CORRection:COLLect:METHod:THRU 1,2

3.4.57 Set Calibration Type to OSL (:SENSe{[1]-200}:CORRection:COLLect:METHod:SOLT1)

Command Format	:SENSe{[1]-200}:CORRection:COLLect:METHod:SOLT1 <numeric>
Instruction	This command sets the calibration type to the 1-port calibration OSL of the specified port, for the selected channel.
Parameter Type	Integer
Parameter Range	1 to 4
Return	None
Default	None
Menu	Cal > Basic Cal > OSL
Example	:SENSe1:CORRection:COLLect:METHod:SOLT1 3

3.4.58 Set Calibration Type to 2-Port SOLT (:SENSe{[1]-200}:CORRection:COLLect:METHod:SOLT2)

Command Format	:SENSe{[1]-200}:CORRection:COLLect:METHod:SOLT2 <numeric 1>,<numeric 2>
Instruction	This command sets the calibration type to the 2-port calibration SOLT of the specified port, for the selected channel.
Parameter Type	Array <numeric 1>: Specifies port number for 2-port calibration. <numeric 2>: Specifies port number for 2-port calibration. If you specify the same port number to 2 port numbers, an error occurs when ex

	executed. The order of the 2 port numbers to be specified is arbitrary.
Parameter Range	1~4
Return	None
Default	None
Menu	Cal > Basic Cal > SOLT
Example	:SENSe1:CORRection:COLLect:MEtHod:SOLT2 1,2

3.4.59 Set Calibration Type to 3-Port SOLT (:SENSe{[1]-200}:CORRection:COLLect:MEtHod:SOLT3)

Command Format	:SENSe{[1]-200}:CORRection:COLLect:MEtHod:SOLT3 <numeric 1>,<numeric 2>,<numeric 3>
Instruction	This command sets the calibration type to the 3-port calibration SOLT between the specified 3 ports, for the selected channel.
Parameter Type	Array <numeric 1>: Specifies port number for 3-port calibration. <numeric 2>: Specifies port number for 3-port calibration. <numeric 3>: Specifies port number for 3-port calibration. If you specify the same port number to 3 port numbers, an error occurs when executed. The order of the 3 port numbers to be specified is arbitrary.
Parameter Range	1~4
Return	None
Default	None
Menu	Cal > Basic Cal > SOLT
Example	:SENSe1:CORRection:COLLect:MEtHod:SOLT3 1,2,4

3.4.60 Set Calibration Type to 4-Port SOLT (:SENSe{[1]-200}:CORRection:COLLect:MEtHod:SOLT4)

Command Format	:SENSe{[1]-200}:CORRection:COLLect:MEtHod:SOLT4 <numeric 1>,<numeric 2>,<numeric 3>,<numeric 4>
Instruction	This command sets the calibration type to the full 4-port calibration SOLT, for the selected channel.
Parameter Type	Array <numeric 1>: Specifies port number for 4-port calibration. <numeric 2>: Specifies port number for 4-port calibration. <numeric 3>: Specifies port number for 4-port calibration. <numeric 4>: Specifies port number for 4-port calibration. If you specify the same port number to 4 port numbers, an error occurs when executed. The order of the 4 port numbers to be specified is arbitrary.
Parameter Range	1~4
Return	None
Default	None
Menu	Cal > Basic Cal > SOLT
Example	:SENSe1:CORRection:COLLect:MEtHod:SOLT4 1,2,3,4

3.4.61 Set Calibration Type to 2-port TRL (:SENSe{[1]-200}:CORRection:COLLect:MEtHod:TRL2)

Command Format	:SENSe{[1]-200}:CORRection:COLLect:MEthod:TRL2 <numeric 1>,<numeric 2>
Instruction	This command sets the calibration type to 2-port TRL between the 2 specified ports, for the selected channel.
Parameter Type	Array <numeric 1>: Specifies port number for TRL 2-port calibration. <numeric 2>: Specifies port number for TRL 2-port calibration. If you specify the same port number to 2 port numbers, an error occurs when executed. the order of the 2 port numbers to be specified is arbitrary.
Parameter Range	1~4
Return	None
Default	None
Menu	Cal > Basic Cal > TRL
Example	:SENSe1:CORRection:COLLect:MEthod:TRL2 1,2

3.4.62 Set Calibration Type to 3-port TRL (:SENSe{[1]-200}:CORRection:COLLect:MEthod:TRL3)

Command Format	:SENSe{[1]-200}:CORRection:COLLect:MEthod:TRL3 <numeric 1>,<numeric 2>,<numeric 3>
Instruction	This command sets the calibration type to 3-port TRL between the 3 specified ports, for the selected channel.
Parameter Type	Array <numeric 1>: Specifies port number for TRL 3-port calibration. <numeric 2>: Specifies port number for TRL 3-port calibration. <numeric 3>: Specifies port number for TRL 3-port calibration. If you specify the same port number to 3 port numbers, an error occurs when executed. the order of the 3 port numbers to be specified is arbitrary.
Parameter Range	1~4
Return	None
Default	None
Menu	Cal > Basic Cal > TRL
Example	:SENSe1:CORRection:COLLect:MEthod:TRL3 1,2,3

3.4.63 Set Calibration Type to 4-port TRL (:SENSe{[1]-200}:CORRection:COLLect:MEthod:TRL4)

Command Format	:SENSe{[1]-200}:CORRection:COLLect:MEthod:TRL4 <numeric 1>,<numeric 2>,<numeric 3>,<numeric 4>
Instruction	This command sets the calibration type to the 4-port calibration TRL between the 4 specified ports, for the selected channel.
Parameter Type	Array <numeric 1>: Specifies port number for TRL 4-port calibration. <numeric 2>: Specifies port number for TRL 4-port calibration. <numeric 3>: Specifies port number for TRL 4-port calibration. <numeric 4>: Specifies port number for TRL 4-port calibration. If you specify the same port number to 4 port numbers, an error occurs when executed. the order of the 4 port numbers to be specified is arbitrary.
Parameter Range	1~4
Return	None

Default	None
Menu	Cal > Basic Cal > TRL
Example	:SENSe1:CORRection:COLLect:METhod:TRL4 1,2,3,4

3.4.64 Get Calibration Type (:SENSe{[1]-200}:CORRection:COLLect:METhod:TYPE?)

Command Format	:SENSe{[1]-200}:CORRection:COLLect:METhod:TYPE?
Instruction	This command reads the selected calibration type of selected channel.
Parameter Type	None
Parameter Range	None
Return	None
Default	None
Menu	None
Example	:SENSe1:CORRection:COLLect:METhod:TRL4 1,2,3,4 :SENSe1:CORRection:COLLect:METhod:TYPE? Return: TRL4

3.4.65 Save Calibration Data(:SENSe{[1]-200}:CORRection:COLLect:SAVE)

Command Format	:SENSe{[1]-200}:CORRection:COLLect:SAVE
Instruction	This command calculates the calibration coefficients depending on the calibration type selection, from the measured calibration data and save it.
Parameter Type	None
Parameter Range	None
Return	None
Default	None
Menu	Cal > Basic Cal > Finish
Example	:SENSe1:CORRection:COLLect:SAVE

3.4.66 Frequency 1 or 2 of Port Extension (:SENSe{[1]-200}:CORRection:EXTension:PORT{[1]|2|3|4}:FREQuency{[1]|2})

Command Format	:SENSe{[1]-200}:CORRection:EXTension:PORT{[1] 2 3 4}:FREQuency{[1] 2} <numeric> :SENSe{[1]-200}:CORRection:EXTension:PORT{[1] 2 3 4}:FREQuency{[1] 2}?
Instruction	This command sets/gets the frequency used for calculation of the loss value of the frequency 1 and 2 of the selected port, for the selected channel.
Parameter Type	Double, unit: Hz
Parameter Range	9kHz~8.5GHz
Return	Double, unit: Hz
Default	1GHz

Menu	Cal > Port Extension > Port Extensions... > Loss > Freq1 or Freq2
Example	

3.4.67 State of Loss Value and Frequency Value (:SENSe{[1]-200}:CORRection:EXTension:PORT{[1]|2|3|4}:INCLude{[1]|2}{:STATe})

Command Format	:SENSe{[1]-200}:CORRection:EXTension:PORT{[1] 2 3 4}:INCLude{[1] 2}{:STATe} {ON OFF 1 0} :SENSe{[1]-200}:CORRection:EXTension:PORT{[1] 2 3 4}:INCLude{[1] 2}{:STATe}
Instruction	This command turns ON/OFF the set of loss value and frequency value of include 1 and 2 of the port 1 to 4, for the selected channel.
Parameter Type	Boolean
Parameter Range	ON OFF 1 0
Return	0 1
Default	OFF
Menu	Cal > Port Extension > Port Extensions... > Loss
Example	:SENSe1:CORRection:EXTension:PORT1:INCLude1 ON :SENSe1:CORRection:EXTension:PORT1:INCLude1? Return: 1

3.4.68 DC Loss of Port Extension (:SENSe{[1]-200}:CORRection:EXTension:PORT{[1]|2|3|4}:LDC)

Command Format	:SENSe{[1]-200}:CORRection:EXTension:PORT{[1] 2 3 4}:LDC <numeric> :SENSe{[1]-200}:CORRection:EXTension:PORT{[1] 2 3 4}:LDC?
Instruction	This command sets/gets the DC loss value of the port 1 to 4, for the selected channel.
Parameter Type	Float, unit dB
Parameter Range	-90 ~ 90dB
Return	Float, unit dB
Default	0dB
Menu	Cal > Port Extension > DC Loss
Example	:SENSe1:CORRection:EXTension:PORT2:LDC 10 :SENSe1:CORRection:EXTension:PORT2:LDC? Return: 10

3.4.69 Loss Value of Port Extension (:SENSe{[1]-200}:CORRection:EXTension:PORT{[1]|2|3|4}:LOSS{[1]|2})

Command Format	:SENSe{[1]-200}:CORRection:EXTension:PORT{[1] 2 3 4}:LOSS{[1] 2} <numeric> :SENSe{[1]-200}:CORRection:EXTension:PORT{[1] 2 3 4}:LOSS{[1] 2}?
Instruction	This command sets/gets the loss value of the loss 1 to 4 of the port 1 to 4, for the selected channel.

Parameter Type	Float, unit dB
Parameter Range	-90 ~ 90dB
Return	Float, unit dB
Default	0dB
Menu	Cal > Port Extension > Port Extensions... > Loss > Loss1 or Loss2
Example	:SENSe1:CORRection:EXTension:PORT1:LOSS1 2 :SENSe1:CORRection:EXTension:PORT1:LOSS1? Return: 2

3.4.70 Delay Time of Port Extension (:SENSe{[1]-200}:CORRection:EXTension:PORT{[1]|2|3|4}:TIME)

Command Format	:SENSe{[1]-200}:CORRection:EXTension:PORT{[1] 2 3 4}:TIME <numeric> :SENSe{[1]-200}:CORRection:EXTension:PORT{[1] 2 3 4}:TIME?
Instruction	This command sets or gets the value of the delay time for the port extension of ports 1 and 4, for the selected channel.
Parameter Type	Float, unit s(second)
Parameter Range	0~10s
Return	Float, unit s(second)
Default	0
Menu	Cal > Port Extension > Time
Example	:SENSe1:CORRection:EXTension:PORT1:TIME 5 :SENSe1:CORRection:EXTension:PORT1:TIME? Return: 5

3.4.71 Delay Distance of Port Extension (:SENSe{[1]-200}:CORRection:EXTension:PORT{[1]|2|3|4}:DISTance)

Command Format	:SENSe{[1]-200}:CORRection:EXTension:PORT{[1] 2 3 4}:DISTance <numeric> :SENSe{[1]-200}:CORRection:EXTension:PORT{[1] 2 3 4}:DISTance?
Instruction	This command sets and returns the port extension delay in physical length (distance).
Parameter Type	Float, unit m(meter), or ft(feet), or in(inches)
Parameter Range	None
Return	Float, unit m(meter), or ft(feet), or in(inches)
Default	0
Menu	Cal > Port Extension > Distance
Example	:SENSe1:CORRection:EXTension:PORT1:DISTance 1 :SENSe1:CORRection:EXTension:PORT1:DISTance? Return: 1

3.4.72 Distance Unit of Port Extension (:SENSe{[1]-200}:CORRection:EXTension:PORT{[1]|2|3|4}:DISTANCE:UNIT)

Command Format	:SENSe{[1]-200}:CORRection:EXTension:PORT{[1] 2 3 4}:DISTANCE:UNIT {METers FEET INCHes} :SENSe{[1]-200}:CORRection:EXTension:PORT{[1] 2 3 4}:DISTANCE:UNIT?
Instruction	This command Sets and returns the units for specifying port extension delay in physical length (distance).
Parameter Type	Enumeration
Parameter Range	METers FEET INCHes
Return	Enumeration
Default	METers
Menu	Cal > Port Extension > Port Extensions... > Delay > Distance Units
Example	:SENSe1:CORRection:EXTension:PORT1:DISTANCE:UNIT INCHes :SENSe1:CORRection:EXTension:PORT1:DISTANCE:UNIT? Return: INCH

3.4.73 State of Port Extension (:SENSe{[1]-200}:CORRection:EXTension[:STATe])

Command Format	:SENSe{[1]-200}:CORRection:EXTension[:STATe] {ON OFF 1 0} :SENSe{[1]-200}:CORRection:EXTension[:STATe]?
Instruction	This command turns ON/OFF or returns the status of the port extension, for the selected channel.
Parameter Type	Boolean
Parameter Range	ON OFF 1 0
Return	Boolean
Default	OFF
Menu	Cal > Port Extension > Port Extension
Example	:SENSe1:CORRection:EXTension ON :SENSe1:CORRection:EXTension? Return: 1

3.4.74 Velocity of Port Extension (:SENSe{[1]-200}:CORRection:EXTension:VELocity)

Command Format	:SENSe{[1]-200}:CORRection:EXTension:PORT{[1] 2 3 4}:VELFactor <numeric> :SENSe{[1]-200}:CORRection:EXTension:PORT{[1] 2 3 4}:VELFactor?
Instruction	This command sets or gets the value of Velocity coefficient, for the selected channel.
Parameter Type	Float
Parameter Range	0 ~ 1
Return	Float
Default	1
Menu	Cal > Port Extension > Velocity
Example	:SENSe1:CORRection:EXTension:PORT1:VELFactor 0.66 :SENSe1:CORRection:EXTension:PORT1:VELFactor? Return: 0.66

3.4.75 State of Velocity Couple (:SENSe{[1]-200}:CORRection:EXTension:PORT{[1]-4}:SYSVelocity)

Command Format	:SENSe{[1]-200}:CORRection:EXTension:PORT{[1]-4}:SYSVelocity {ON OFF 1 0} :SENSe{[1]-200}:CORRection:EXTension:PORT{[1]-4}:SYSVelocity?
Instruction	This command sets or returns the state of coupling with the system Velocity Factor value.
Parameter Type	Boolean
Parameter Range	ON OFF 1 0
Return	Boolean
Default	ON
Menu	Cal > Port Extension > Port Extensions... > Velocity > Couple to system Velocity Factor
Example	:SENSe1:CORRection:EXTension:PORT1:SYSVelocity 0 :SENSe1:CORRection:EXTension:PORT1:SYSVelocity? Return: 0

3.4.76 Clear Port Extension Data (:SENSe{[1]-200}:CORRection:EXTension:AUTO:RESet)

Command Format	:SENSe{[1]-200}:CORRection:EXTension:AUTO:RESet
Instruction	This command clears old port extension delay and loss data in preparation for acquiring new data.
Parameter Type	None
Parameter Range	None
Return	None
Default	None
Menu	Cal > Port Extension > Port Extension... > Reset
Example	:SENSe1:CORRection:EXTension:AUTO:RESet

3.4.77 Calculate Method for Auto Port Extension (:SENSe{[1]-200}:CORRection:EXTension:AUTO:CONFIg)

Command Format	:SENSe{[1]-200}:CORRection:EXTension:AUTO:CONFIg {CSPN AMKR USPN} :SENSe{[1]-200}:CORRection:EXTension:AUTO:CONFIg?
Instruction	This command sets/gets the frequency point to calculate the auto port extension, for the selected channel.
Parameter Type	Enumeration
Parameter Range	CSPN AMKR USPN
Return	Enumeration
Default	CSPN
Menu	Cal > Port Extension > Automatic Port Extension > Method
Example	:SENSe1:CORRection:EXTension:AUTO:CONFIg USPN :SENSe1:CORRection:EXTension:AUTO:CONFIg?

	Return: USPN
--	--------------

3.4.78 Adjust for Mismatch State (:SENSe{[1]-200}:CORRection:EXTension:AUTO:DCOFFset)

Command Format	:SENSe{[1]-200}:CORRection:EXTension:AUTO:DCOFFset {ON OFF 1 0} :SENSe{[1]-200}:CORRection:EXTension:AUTO:DCOFFset?
Instruction	This command enables/disables or gets the usage of DC Offset value for the results of the auto port extension, for the selected channel.
Parameter Type	Boolean
Parameter Range	ON OFF 1 0
Return	Boolean
Default	ON
Menu	Cal > Port Extension > Automatic Port Extension > Setting > Adjust for Mismatch
Example	:SENSe1:CORRection:EXTension:AUTO:DCOFFset 0 :SENSe1:CORRection:EXTension:AUTO:DCOFFset? Return: 0

3.4.79 State of the Loss Compensation (:SENSe{[1]-200}:CORRection:EXTension:AUTO:LOSS)

Command Format	:SENSe{[1]-200}:CORRection:EXTension:AUTO:LOSS {ON OFF 1 0} :SENSe{[1]-200}:CORRection:EXTension:AUTO:LOSS?
Instruction	This command turns ON/OFF or gets the status of the loss compensation for the results of the auto port extension, for the selected channel.
Parameter Type	Boolean
Parameter Range	ON OFF 1 0
Return	Boolean
Default	ON
Menu	Cal > Port Extension > Automatic Port Extension > Setting > Include Loss
Example	:SENSe1:CORRection:EXTension:AUTO:LOSS OFF :SENSe1:CORRection:EXTension:AUTO:LOSS? Return: 0

3.4.80 User Span Start Frequency(:SENSe{[1]-200}:CORRection:EXTension:AUTO:START)

Command Format	:SENSe{[1]-200}:CORRection:EXTension:AUTO:START <numeric> :SENSe{[1]-200}:CORRection:EXTension:AUTO:START?
Instruction	This command gets/sets the start frequency within the frequency range of the user specified auto port extension, for the selected channel.
Parameter Type	Float, unit: Hz
Parameter Range	9 kHz ~ 8.5 GHz
Return	Float, unit: Hz
Default	100 kHz

Menu	Cal > Port Extension > Automatic Port Extension > User Span > Start
Example	:SENSe1:CORRection:EXTension:AUTO:STARt 1e6 :SENSe1:CORRection:EXTension:AUTO:STARt? Return: 1000000

3.4.81 User Span Start Frequency(:SENSe{[1]-200}:CORRection:EXTension:AUTO:STOP)

Command Format	:SENSe{[1]-200}:CORRection:EXTension:AUTO:STOP <numeric> :SENSe{[1]-200}:CORRection:EXTension:AUTO:STOP?
Instruction	This command get/set the stop frequency within the frequency range of the user specified auto port extension, for the selected channel.
Parameter Type	Float, unit:Hz
Parameter Range	9 kHz ~ 8.5 GHz
Return	Float, unit:Hz
Default	8.5 GHz
Menu	Cal > Port Extension > Automatic Port Extension > User Span > Stop
Example	:SENSe1:CORRection:EXTension:AUTO:STOP 1e9 :SENSe1:CORRection:EXTension:AUTO:STOP? Return: 1000000000

3.4.82 Velocity Factor (:SENSe{[1]-200}:CORRection:RVELocity:COAX)

Command Format	:SENSe{[1]-200}:CORRection:RVELocity:COAX <numeric> :SENSe{[1]-200}:CORRection:RVELocity:COAX?
Instruction	This command sets/gets the velocity factor, for selected channel.
Parameter Type	Float
Parameter Range	0~1
Return	Float
Default	1
Menu	Scale > Electrical Delay > Velocity Factor
Example	:SENSe1:CORRection:RVELocity:COAX 0.5 :SENSe1:CORRection:RVELocity:COAX? Return: 0.5

3.4.83 Correction State (:SENSe{[1]-200}:CORRection:STATe)

Command Format	:SENSe{[1]-200}:CORRection:STATe {ON OFF 1 0} :SENSe{[1]-200}:CORRection:STATe?
Instruction	This turns ON/OFF or gets the status of the error correction of selected channel
Parameter Type	Boolean
Parameter Range	ON OFF 1 0
Return	Boolean
Default	OFF

Menu	Cal > Cal > Correction
Example	:SENSe1:CORRection:STATe ON :SENSe1:CORRection:STATe? Return: 1

3.4.84 System Impedance (:SENSe:CORRection:IMPedance[:INPut][:MAGNitude])

Command Format	:SENSe:CORRection:IMPedance[:INPut][:MAGNitude] <numeric> :SENSe:CORRection:IMPedance[:INPut][:MAGNitude]?
Instruction	This command sets/gets the system characteristic impedance (Z0) value.
Parameter Type	Float
Parameter Range	0~1000
Return	Float
Default	50
Menu	Scale > Constants > System Z0
Example	:SENSe:CORRection:IMPedance 75 :SENSe:CORRection:IMPedance? Return: 75

3.4.85 Get Corrected Data Array (:SENSe{[1]-200}:DATA:CORRdata? S<XY>)

Command Format	:SENSe{[1]-200}:DATA:CORRdata? S<XY>
Instruction	This command gets S-Parameter data of selected channel.
Parameter Type	Integer
Parameter Range	"S<XY>", Where X: 1 to 4 Y: 1 to 4
Return	Indicates the array data of NOP (number of measurement points)x2. Where n is an integer between 1 and NOP. Data(nx2-2): Real part of the data (complex number) at the n-th measurement point. Data(nx2-1): Imaginary part of the data (complex number) at the n-th measurement point. The index of the array starts from 0.
Default	None
Menu	None
Example	:SENSe1:DATA:CORRdata? S11

3.4.86 Get Raw Data Array(:SENSe{[1]-200}:DATA:RAWData? S<XY>)

Command Format	:SENSe{[1]-200}:DATA:RAWData? S<XY>
Instruction	This command gets the raw data of selected channel.

Parameter Type	Integer
Parameter Range	" S<XY>", Where X: 1 to 4 Y: 1 to 4
Return	Indicates the array data of NOP (number of measurement points)×2. Where n is an integer between 1 and NOP. Data(n×2-2): Real part of the data (complex number) at the n-th measurement point. Data(n×2-1): Imaginary part of the data (complex number) at the n-th measurement point. The index of the array starts from 0.
Default	None
Menu	None
Example	:SENSe1:DATA:RAWData? S11

3.4.87 Center Frequency (:SENSe{[1]-200}:FREQuency:CENTer)

Command Format	:SENSe{[1]-200}:FREQuency:CENTer <numeric> :SENSe{[1]-200}:FREQuency:CENTer?
Instruction	This command sets/gets the center value of the sweep range of selected channel.
Parameter Type	Float, unit: Hz
Parameter Range	9 kHz ~ 8.5 GHz
Return	Float, unit: Hz
Default	4.25005 GHz
Menu	Freq > Center
Example	:SENSe1:FREQuency:CENTer 1e9 :SENSe1:FREQuency:CENTer? Return: 1000000000

3.4.88 Cw Frequency (:SENSe{[1]-200}:FREQuency:CW)

Command Format	:SENSe{[1]-200}:FREQuency:CW <numeric> :SENSe{[1]-200}:FREQuency:CW?
Instruction	This command sets/gets the fixed frequency (CW frequency) for the power sweep for channels 1 to 200.
Parameter Type	Float, unit: Hz
Parameter Range	9 kHz ~ 8.5 GHz
Return	Float, unit: Hz
Default	1 GHz
Menu	Freq > CW
Example	:SENSe1:FREQuency:CW 2e9 :SENSe1:FREQuency:CW? Return: 2000000000

3.4.89 Cw Frequency (:SENSe{[1]-200}:FREQuency:FIXed)

Command Format	:SENSe{[1]-200}:FREQuency:FIXed <numeric> :SENSe{[1]-200}:FREQuency:FIXed?
Instruction	This command sets/gets the fixed frequency (CW frequency) for the power sweep for channels 1 to 200.
Parameter Type	Float, unit: Hz
Parameter Range	9 kHz ~ 8.5 GHz
Return	Float, unit: Hz
Default	1 GHz
Menu	Freq > CW
Example	:SENSe1:FREQuency:FIXed 3e9 :SENSe1:FREQuency:FIXed? Return: 3000000000

3.4.90 Frequency of All Measurement Points (:SENSe{[1]-200}:FREQuency:DATA?)

Command Format	:SENSe{[1]-200}:FREQuency:DATA?
Instruction	This command reads the frequencies at all measurement points of channels 1 to 200.
Parameter Type	None
Parameter Range	None
Return	Data array
Default	None
Menu	None
Example	:SENSe1:FREQuency:DATA?

3.4.91 Frequency SPAN (:SENSe{[1]-200}:FREQuency:SPAN)

Command Format	:SENSe{[1]-200}:FREQuency:SPAN <numeric> :SENSe{[1]-200}:FREQuency:SPAN?
Instruction	This command sets/gets the span value of the sweep range of selected channel.
Parameter Type	Float, unit: Hz
Parameter Range	9 kHz ~ 8.5 GHz
Return	Float, unit: Hz
Default	8.4999 GHz
Menu	Freq > Span
Example	:SENSe1:FREQuency:SPAN 1e6 :SENSe1:FREQuency:SPAN? Return: 1000000

3.4.92 Start Frequency (:SENSe{[1]-200}:FREQuency:STARt)

Command Format	:SENSe{[1]-200}:FREQuency:STARt <numeric> :SENSe{[1]-200}:FREQuency:STARt?
Instruction	This command sets/gets the start value of the sweep range of selected channel.
Parameter Type	Float, unit: Hz
Parameter Range	9 kHz ~ 8.5 GHz
Return	Float, unit: Hz
Default	9 kHz
Menu	Freq > Start
Example	:SENSe1:FREQuency:STARt 100e3 :SENSe1:FREQuency:STARt? Return: 100000

3.4.93 Stop Frequency (:SENSe{[1]-200}:FREQuency:STOP)

Command Format	:SENSe{[1]-200}:FREQuency:STOP <numeric> :SENSe{[1]-200}:FREQuency:STOP?
Instruction	This command sets/gets the stop value of the sweep range of selected channel.
Parameter Type	Float, unit: Hz
Parameter Range	9 kHz ~ 8.5 GHz
Return	Float, unit: Hz
Default	8.5 GHz
Menu	Freq > Stop
Example	:SENSe1:FREQuency:STOP 1e9 :SENSe1:FREQuency:STOP? Return: 1000000000

3.4.94 IF Bandwidth Per Port (:SENSe{[1]-200}:SEGMent:LIST:BWIDth:PORT:STATe)

Command Format	:SENSe{[1]-200}:SEGMent:LIST:BWIDth:PORT:STATe {ON OFF 1 0} :SENSe{[1]-200}:SEGMent:LIST:BWIDth:PORT:STATe?
Instruction	This command turns ON/OFF or gets the status of IFBW Per Port control in the segment sweep table.
Parameter Type	Boolean
Parameter Range	ON OFF 1 0
Return	0 1
Default	OFF
Menu	Sweep > Segment Table > Segment Table Setting > IF Bandwidth Per Port
Example	:SENSe1:SEGMent:LIST:BWIDth:PORT:STATe 1 :SENSe1:SEGMent:LIST:BWIDth:PORT:STATe? Return: 1

3.4.95 IFBW of Each Segment (:SENSe{[1]-200}:SEGMe nt:LIST:BWIDth:PORT{[1]-4}[:RESolution])

Command Format	:SENSe{[1]-200}:SEGMe nt:LIST:BWIDth:PORT{[1]-4}[:RESolution] <value 1>,<value 2>,...,<value N> :SENSe{[1]-200}:SEGMe nt:LIST:BWIDth:PORT{[1]-4}[:RESolution]?
Instruction	This command sets/gets the IFBW of each segment for the selected port and channel. Indicates the array data of NOP (number of total segment numbers). Where n is an integer between 1 and NOP.
Parameter Type	Data array
Parameter Range	None
Return	Data array
Default	10 kHz
Menu	Sweep > Segment Table > Segment Table Setting
Example	:SENSe1:SEGMe nt:LIST:BWIDth:PORT1:RESolution 10e3,20e3,30e3 :SENSe1:SEGMe nt:LIST:BWIDth:PORT1? Return: 1.000000000000e+04,2.000000000000e+04,3.000000000000e+04

3.4.96 State of Each Segment (:SENSe{[1]-200}:SEGMe nt:LIST:CONTRol:DATA)

Command Format	:SENSe{[1]-200}:SEGMe nt:LIST:CONTRol:DATA <state 1>,<state 2>,...,<state N> :SENSe{[1]-200}:SEGMe nt:LIST:CONTRol:DATA?
Instruction	This command sets/gets the state of each segment in the segment sweep table of selected channel. Indicates the array data of NOP (number of total segment numbers). Where n is an integer between 1 and NOP.
Parameter Type	Data array
Parameter Range	None
Return	Data array
Default	None
Menu	Sweep > Segment Table > Segment Table Setting
Example	:SENSe1:SEGMe nt:LIST:CONTRol:DATA 1,1,0 :SENSe1:SEGMe nt:LIST:CONTRol:DATA? Return: 1,1,0

3.4.97 Individual Segment State Control (:SENSe{[1]-200}:SEGMe nt:LIST:CONTRol:STATe)

Command Format	:SENSe{[1]-200}:SEGMe nt:LIST:CONTRol:STATe {ON OFF 1 0} :SENSe{[1]-200}:SEGMe nt:LIST:CONTRol:STATe?
Instruction	This command turns ON/OFF or gets the individual segment state control in the segment sweep table.
Parameter Type	Boolean
Parameter Range	ON OFF 1 0

Return	Boolean
Default	1
Menu	None
Example	:SENSe1:SEGMent:LIST:CONTRol:STATe 0 :SENSe1:SEGMent:LIST:CONTRol:STATe? Return: 0

3.4.98 Individual Power Control (:SENSe{[1]-200}:SEGMent:LIST:POWer:PORT:STATe)

Command Format	:SENSe{[1]-200}:SEGMent:LIST:POWer:PORT:STATe {ON OFF 1 0} :SENSe{[1]-200}:SEGMent:LIST:POWer:PORT:STATe?
Instruction	This command turns ON/OFF the individual power control in the segment sweep table. This command overrides the coupled port power control.
Parameter Type	Boolean
Parameter Range	ON OFF 1 0
Return	Boolean
Default	0
Menu	Sweep > Segment Table > Segment Table Setting > Power Level
Example	:SENSe1:SEGMent:LIST:POWer:PORT:STATe 1 :SENSe1:SEGMent:LIST:POWer:PORT:STATe? Return: 1

3.4.99 Power Level of Each Segment (:SENSe{[1]-200}:SEGMent:LIST:POWer:PORT{[1]-4}[:LEVel][:IMMEDIATE][:AMPLitude])

Command Format	:SENSe{[1]-200}:SEGMent:LIST:POWer:PORT{[1]-4}[:LEVel][:IMMEDIATE][:AMPLitude] <value1>,<value2>,...,<value N> :SENSe{[1]-200}:SEGMent:LIST:POWer:PORT{[1]-4}[:LEVel][:IMMEDIATE][:AMPLitude]?
Instruction	This command sets/gets the power level of each segment for the selected port and channel. Indicates the array data of NOP (number of total segment numbers). Where n is an integer between 1 and NOP.
Parameter Type	Data array
Parameter Range	-120~120dB
Return	Data array
Default	0
Menu	Sweep > Segment Table > Segment Table Setting
Example	:SOURce1:POWer:PORT:COUPlE 1 :SENSe1:SEGMent:DATA 5,0,0,1,0,0,3,9000,1e+06,21,-5,1e+09,2e+09,61,1,3e+09,4e+09,101,-5 :SENSe1:SEGMent:LIST:POWer:PORT1 -10,-20,-15 :SENSe1:SEGMent:LIST:POWer:PORT1? Return: -1.000000000000e+01,-2.000000000000e+01,-1.500000000000e+01 :SOURce1:POWer:PORT:COUPlE 0 :SENSe1:SEGMent:LIST:POWer:PORT2? Return: -5.000000000000e+00,1.000000000000e+00,-5.000000000000e+00

3.4.100 Total Sweep Points of Segment Sweep (:SENSe{[1]-200}:SEGMENT:SWEep:POINTs?)

Command Format	:SENSe{[1]-200}:SEGMENT:SWEep:POINTs?
Instruction	This command reads the total number of the measurement points of all segments, for the segment sweep table of selected channel.
Parameter Type	None
Parameter Range	None
Return	Integer
Default	21
Menu	Sweep > Segment Table > Segment Table Setting
Example	:SENSe1:SEGMENT:DATA 5,0,0,0,0,0,3,9000,1e+06,21,1e+09,2e+09,61,3e+09,4e+09,101 :SENSe1:SEGMENT:SWEep:POINTs? Return: 183

3.4.101 Total Sweep Time of Segment Sweep (:SENSe{[1]-200}:SEGMENT:SWEep:TIME[:DATA]?)

Command Format	:SENSe{[1]-200}:SEGMENT:SWEep:TIME[:DATA]?
Instruction	This command reads the total sweep time (including sweep delay time) of all segments, for the segment sweep table of the selected channel.
Parameter Type	None
Parameter Range	None
Return	Float, unit: s (second)
Default	None
Menu	Sweep > Segment Table > Segment Table Setting
Example	:SENSe1:SEGMENT:DATA 5,0,0,0,0,1,3,9000,1e+06,21,1,1e+09,2e+09,61,5,3e+09,4e+09,101,10 :SENSe1:SEGMENT:SWEep:TIME? Return: 16

3.4.102 Segment Sweep Table (:SENSe{[1]-200}:SEGMENT:DATA)

Command Format	:SENSe{[1]-200}:SEGMENT:DATA <String> :SENSe{[1]-200}:SEGMENT:DATA?
Instruction	This command creates/gets the segment sweep table of selected channel.
Parameter Type	Data array
Parameter Range	Indicates the array data arranged in the following order (for the segment sweep table); where N is the number of segments (specified with <segm>) and n is an integer between 1 and N. Data = {<buf>,<stim>,<ifbw>,<pow>,,<swp>,<time>,<segm>, <star 1>,<stop 1>,<nop 1>,<ifbw 1>,<pow 1>,<del 1>,<swp 1>,<time 1>,..., <star n>,<stop

	<p>n>,<nop n>,<ifbw n>,<pow n>,<del n>,<swp n>,<time n>,... , <star N>,<stop N>,<nop N>,<ifbw N>,<pow N>,<del N>,<swp N>,<time N>}</p> <p>Each parameter in the above array data is detailed below:</p> <p><buf>:Always specify 5. <stim>:Stimulus setting mode 0:Specifies with start/stop values 1:Specifies with center/span values <ifbw>:ON/OFF of the IF bandwidth setting for each segment 0:OFF, 1:ON <pow>:ON/OFF of the power setting for each segment 0:OFF, 1:ON :ON/OFF of the sweep delay time setting for each segment 0:OFF, 1:ON <time>:ON/OFF of the sweep time setting for each segment 0:OFF, 1:ON <segm>:Number of segments Specify an integer ranging 1 to 201. <star n>:Start value/center value of the n-th segment <stop n>:Stop value/span value of the n-th segment <nop n>:Number of measurement points of the n-th segment <ifbw n>:IF bandwidth of the n-th segment Not necessary when the IF bandwidth setting for each segment is OFF (<ifbw>:0). <pow n>:Power of the n-th segment Not necessary when the power setting for each segment is OFF (<pow>:0). <del n>:Sweep delay time of the n-th segment Not necessary when the sweep delay time setting for each segment is OFF (:0). <time n> Sweep time of the n-th segment Not necessary when the sweep time setting for each segment is OFF (<time>:0).</p>
Return	Data array
Default	5,0,0,0,0,0,1,100000,1e6,21
Menu	Sweep > Segment Table > Segment Table Setting
Example	<pre> :SENSe1:SEGMent:DATA 5,0,0,0,0,0,2,9000,1e+06,21,1e+09,2e+09,61 :SENSe1:SEGMent:DATA? Return: 5.000000000000e+00,0.000000000000e+00,0.000000000000e+00,0.000000000000e+00,0.000000000000e+00,0.000000000000e+00,2.000000000000e+00,9.000000000000e+03,1.000000000000e+06,2.100000000000e+01,1.000000000000e+09,2.000000000000e+09,6.100000000000e+01 </pre>

3.4.103 Sweep Delay (:SENSe{[1]-200}:SWEep:DELay)

Command Format	:SENSe{[1]-200}:SWEep:DELay <numeric> :SENSe{[1]-200}:SWEep:DELay?
Instruction	This command sets/gets the sweep delay time of selected channel.
Parameter Type	Float, unit: s (second)
Parameter Range	None
Return	Float, unit: s (second)
Default	0
Menu	Sweep > Sweep Delay
Example	<pre> :SENSe1:SWEep:DELay 1 :SENSe1:SWEep:DELay? Return: 1 </pre>

3.4.104 Sweep Point (:SENSe{[1]-200}:SWEep:POINts)

Command Format	:SENSe{[1]-200}:SWEep:POINts <numeric> :SENSe{[1]-200}:SWEep:POINts?
Instruction	This command sets/gets the number of measurement points of selected channel.
Parameter Type	Integer
Parameter Range	None
Return	Integer
Default	201
Menu	Sweep > Sweep Points
Example	:SENSe1:SWEep:POINts 251 :SENSe1:SWEep:POINts? Return: 251

3.4.105 Auto Sweep (:SENSe{[1]-200}:SWEep:TIME:AUTO)

Command Format	:SENSe{[1]-200}:SWEep:TIME:AUTO {ON OFF 1 0} :SENSe{[1]-200}:SWEep:TIME:AUTO?
Instruction	This command sets/gets whether to automatically set the sweep time of selected channel.
Parameter Type	Boolean
Parameter Range	ON OFF 1 0
Return	0 1
Default	ON
Menu	Sweep > Sweep Mode
Example	:SENSe1:SWEep:TIME:AUTO 0 :SENSe1:SWEep:TIME:AUTO? Return: 0

3.4.106 Sweep Time (:SENSe{[1]-200}:SWEep:TIME[:DATA])

Command Format	:SENSe{[1]-200}:SWEep:TIME[:DATA] <numeric> :SENSe{[1]-200}:SWEep:TIME[:DATA]?
Instruction	This command sets/gets the sweep time of selected channel.
Parameter Type	Float, unit: s (second)
Parameter Range	None
Return	Float, unit: s (second)
Default	None
Menu	Sweep > Sweep Time
Example	:SENSe1:SWEep:TIME 2 :SENSe1:SWEep:TIME? Return: 2

3.4.107 Sweep Type (:SENSe{[1]-200}:SWEep:TYPE)

Command Format	:SENSe{[1]-200}:SWEep:TYPE {LINear LOGarithmic SEGMENT POWer CW} :SENSe{[1]-200}:SWEep:TYPE?
Instruction	This command sets/gets the sweep type of selected channel.
Parameter Type	Enumeration
Parameter Range	<ul style="list-style-type: none"> ● "LINear":Sets the sweep type to the linear sweep. ● "LOGarithmic":Sets the sweep type to the log sweep. ● "SEGMENT":Sets the sweep type to the segment sweep. ● "POWer":Sets the sweep type to the power sweep ● "CW":Sets the sweep type to the constant power sweep
Return	Enumeration
Default	LINear
Menu	Sweep > Sweep Type
Example	:SENSe1:SWEep:TYPE SEGMENT :SENSe1:SWEep:TYPE? Return: SEGM

3.5 Trigger Subsystem

3.5.1 Trigger Source (:TRIGger[:SEQuence]:SOURce)

Command Format	:TRIGger[:SEQuence]:SOURce {INTernal EXTernal MANual BUS} :TRIGger[:SEQuence]:SOURce?
Instruction	This command sets/gets the trigger source from the following 4 types: <ul style="list-style-type: none"> ● Internal Trigger Uses the internal trigger to generate continuous triggers automatically. ● External Trigger Generates a trigger when the trigger signal is inputted externally via the Ext Trig connector or the handler interface. ● Manual Trigger Generates a trigger when the key operation of Trigger > Trigger is executed from the front panel. ● Bus Trigger Generates a trigger when the SCPI.IEEE4882.TRG object is executed.
Parameter Type	Enumeration
Parameter Range	INTernal EXTernal MANual BUS
Return	Enumeration
Default	INTernal
Menu	Trigger > Trigger Source
Example	:TRIGger:SOURce EXTernal :TRIGger:SOURce? Return: EXT

3.5.2 Trigger Scope (:TRIGger[:SEQuence]:SCOPE)

Command Format	:TRIGger[:SEQuence]:SCOPE {ALL ACTive} :TRIGger[:SEQuence]:SCOPE?
Instruction	This command sets/gets the effective scope of triggering. When this function is enabled with a value of "ACTive", only active channel is triggered. When this function is enabled with a value of "ALL", all channels are triggered.
Parameter Type	Enumeration
Parameter Range	ALL ACTive
Return	Enumeration
Default	ALL
Menu	Trigger > Trigger Scope
Example	:TRIGger:SCOPE ACTive :TRIGger:SCOPE? Return: ACT

3.5.3 Trigger Event (:TRIGger[:SEQuence]:POINT)

Command Format	:TRIGger[:SEQuence]:POINT {ON OFF 1 0} :TRIGger[:SEQuence]:POINT?
Instruction	This command turns ON/OFF or returns the status of the point trigger feature.

Parameter Type	Boolean
Parameter Range	ON OFF 1 0
Return	Boolean
Default	OFF
Menu	Trigger > Trigger Setup > Trigger Event
Example	:TRIGger:POINt 1 :TRIGger:POINt? Return: 1

3.5.4 Polarity of the External Trigger Input Port (:TRIGger:SEQuence:EXTErnal:SLOPe)

Command Format	:TRIGger:SEQuence:EXTErnal:SLOPe {POSitive NEGative} :TRIGger:SEQuence:EXTErnal:SLOPe?
Instruction	This command sets/gets the polarity of the External Trigger Input Port.
Parameter Type	Enumeration
Parameter Range	POSitive NEGative
Return	Enumeration
Default	POSitive
Menu	Trigger > Trigger Setup > Ext Trig Input
Example	:TRIGger:SEQuence:EXTErnal:SLOPe NEGative :TRIGger:SEQuence:EXTErnal:SLOPe? Return: NEG

3.5.5 Delay of the External Trigger Source (:TRIGger[:SEQuence]:EXTErnal:DELAy)

Command Format	:TRIGger[:SEQuence]:EXTErnal:DELAy <numeric> :TRIGger[:SEQuence]:EXTErnal:DELAy?
Instruction	This command sets/gets the time that it takes from receiving the trigger to starting measurement when the trigger source is external.
Parameter Type	Float, unit: s (second)
Parameter Range	None
Return	Float, unit: s (second)
Default	0
Menu	Trigger > Trigger Setup > Trigger Delay
Example	:TRIGger:EXTErnal:DELAy 1 :TRIGger:EXTErnal:DELAy? Return: 1

3.5.6 Low Latency of the External Trigger Source (:TRIGger[:SEQuence]:EXTErnal:LLATency[:STATe])

Command Format	:TRIGger[:SEQuence]:EXTErnal:LLATency[:STATe] {ON OFF 1 0} :TRIGger[:SEQuence]:EXTErnal:LLATency[:STATe]?
----------------	--

Instruction	This command turns ON/OFF or returns the status of the low-latency external trigger feature. When turning on the low-latency external trigger feature, the point trigger feature must be set to on and the trigger source must be set to external trigger.
Parameter Type	Boolean
Parameter Range	ON OFF 1 0
Return	Boolean
Default	0
Menu	Trigger > Trigger Setup > Low Latency
Example	:TRIGger:EXTernal:LLATency 1 :TRIGger:EXTernal:LLATency? Return: 1

3.5.7 External Trigger Output Port State (:TRIGger:OUTPut.STATE)

Command Format	:TRIGger:OUTPut:STATe {ON OFF 1 0} :TRIGger:OUTPut:STATe?
Instruction	This command sets/gets the External Trigger Output Port state.
Parameter Type	Boolean
Parameter Range	ON OFF 1 0
Return	Boolean
Default	0
Menu	Trigger > Trigger Setup > Ext Trig output
Example	:TRIGger:OUTPut:STATe 1 :TRIGger:OUTPut:STATe? Return: 1

3.5.8 Polarity of the Pulse (:TRIGger:OUTPut:POLarity)

Command Format	:TRIGger:OUTPut:POLarity {POSitive NEGative} :TRIGger:OUTPut:POLarity?
Instruction	This command sets/gets the polarity of the pulse generated by the External Trigger Output Port.
Parameter Type	Enumeration
Parameter Range	POSitive NEGative
Return	Enumeration
Default	POSitive
Menu	Trigger > Trigger Setup > Polarity
Example	:TRIGger:OUTPut:POLarity NEGative :TRIGger:OUTPut:POLarity? Return: NEG

3.5.9 Position of the Pulse (:TRIGger:OUTPut:POSition)

Command Format	:TRIGger:OUTPut:POSition {AFTer BEFore} :TRIGger:OUTPut:POSition?
Instruction	This command sets/gets the position of the External Trigger Output Port.
Parameter Type	Enumeration
Parameter Range	AFTer BEFore
Return	Enumeration
Default	AFTer
Menu	Trigger > Trigger Setup > Position
Example	:TRIGger:OUTPut:POSition BEFore :TRIGger:OUTPut:POSition? Return: BEF

3.5.10 Trigger Comand (:TRIGger[:SEQuence][:IMMedia te])

Command Format	:TRIGger[:SEQuence][:IMMediate]
Instruction	This command stops the current sweeps and immediately sends a trigger. The n, after measurement is executed once, it goes back to the hold state. This command requires trigger source to be Manual, External or Bus.
Parameter Type	None
Parameter Range	None
Return	None
Default	None
Menu	None
Example	:TRIG

3.5.11 Trigger Comand (:TRIGger[:SEQuence]:SINGle)

Command Format	:TRIGger[:SEQuence]:SINGle
Instruction	This command stops the current sweeps and immediately sends a trigger. The n, after measurement is executed once, it goes back to the hold state. This command requires trigger source to be Manual, External or Bus. The execution of the object finishes when the measurement (all of the sweep) initiated with this object is complete. In other words, you can wait for the end of the measurement using the “*OPC?” object.
Parameter Type	None
Parameter Range	None
Return	None
Default	None
Menu	None
Example	:TRIG:SING

3.5.12 Trigger Restart (:ABORt)

Command Format	:ABORt
Instruction	This command stops the current sweeps and immediately sends a trigger. Then, after measurement is executed once, it goes back to the idle state.
Parameter Type	None
Parameter Range	None
Return	None
Default	None
Menu	Trigger > Restart
Example	:ABORt

3.6 Initiate Subsystem

3.6.1 Continuous Initiation Mode (:INITiate{[1]-200}:CONTInuous {ON|OFF|1|0})

Command Format	:INITiate{[1]-200}:CONTInuous {ON OFF 1 0} :INITiate{[1]-200}:CONTInuous?
Instruction	This command turns ON/OFF the continuous initiation mode of selected channel in the trigger system.
Parameter Type	Boolean
Parameter Range	ON OFF 1 0 True or ON:Turns ON the continuous initiation mode. False or OFF:Turns OFF the continuous initiation mode.
Return	Boolean
Default	0
Menu	Trigger > Continuous/Hold
Example	:INITiate1:CONTInuous 1 :INITiate1:CONTInuous? Return: 1

3.6.2 Single Mode (:INITiate{[1]-200}[:IMMEDIATE])

Command Format	:INITiate{[1]-200}[:IMMEDIATE]
Instruction	This command changes the state of each channel of selected channel to the initiation state in the trigger system. When this object is executed for a channel in the hold state, it goes into the single state immediately. Then, after measurement is executed once, it goes back to the hold state.
Parameter Type	None
Parameter Range	None
Return	None
Default	None
Menu	Trigger > Single
Example	:INITiate1

3.7 Output Subsystem

3.7.1 Output State (:OUTPut[:STATe])

Command Format	:OUTPut[:STATe] {ON OFF 1 0} :OUTPut[:STATe]?
Instruction	This command turns on/off the stimulus signal output. Measurement cannot be made until the stimulus signal output is turned ON.
Parameter Type	Boolean
Parameter Range	ON OFF 1 0
Return	Boolean
Default	ON
Menu	Power > RF Power
Example	:OUTPut 0 :OUTPut? Return: 0

3.8 Memory Subsystem

3.8.1 Copy File (:MMEMory:COpy)

Command Format	:MMEMory:COpy <string 1>,<string 2>
Instruction	This command copies a file. If the specified copy source file does not exist, an error occurs when executed and the object is ignored. Notice that, if a file with the same name as the specified copy destination file name exists, its contents are overwritten. The source file and copy destination file is separated by comma.
Parameter Type	String
Parameter Range	255 characters or less
Return	None
Default	None
Menu	None
Example	:MMEMory:COpy "local/test1.csv","local/test2.csv"

3.8.2 Delete File (:MMEMory:DElete)

Command Format	:MMEMory:DElete <string>
Instruction	This command deletes an existing file or directory (folder). If the specified file or directory does not exist, an error occurs when executed and the object is ignored.
Parameter Type	String
Parameter Range	255 characters or less
Return	None
Default	None
Menu	None
Example	:MMEMory:DElete "local/test1.csv"

3.8.3 Store Fdata (:MMEMory:STORe:FDATa)

Command Format	:MMEMory:STORe:FDATa <string>
Instruction	This command saves the formatted data array into a file in the CSV format (extension ".csv"), for the active trace of the active channel. If a file with the same name as the specified file name exists, its contents are overwritten.
Parameter Type	String
Parameter Range	255 characters or less
Return	None
Default	None
Menu	Save Recall > Save Other > Save Trc Data
Example	:MMEMory:STORe:FDATa "local/test.csv"

3.8.4 Load Limit Table (:MMEMory:LOAD:LIMit)

Command Format	:MMEMory:LOAD:LIMit <string>
Instruction	This command recalls the specified limit table file, from the limit table for the active trace of the active channel.
Parameter Type	String
Parameter Range	255 characters or less
Return	None
Default	None
Menu	Math > Analysis > Limit > Load Table
Example	:MMEMory:LOAD:LIMit "local/test.csv"

3.8.5 Store Limit Table (:MMEMory:STORE:LIMit)

Command Format	:MMEMory:STORE:LIMit <string>
Instruction	This command saves the limit table of the active trace of the active channel into a file in the CSV format (extension ".csv"). If a file with the same name as the specified file name exists, its contents are overwritten.
Parameter Type	String
Parameter Range	255 characters or less
Return	None
Default	None
Menu	Math > Analysis > Limit > Save Table
Example	:MMEMory:STORE:LIMit "local/test.csv"

3.8.6 Load Ripple Limit Table (:MMEMory:LOAD:RLIMit)

Command Format	:MMEMory:LOAD:RLIMit <string>
Instruction	This command recalls the specified ripple limit table file, from the ripple limit table for the active trace of the active channel.
Parameter Type	String
Parameter Range	255 characters or less
Return	None
Default	None
Menu	Math > Analysis > Limit > Ripple > Load Table
Example	:MMEMory:LOAD:RLIMit "local/test.csv"

3.8.7 Store Ripple Limit Table (:MMEMory:STORE:RLIMit)

Command Format	:MMEMory:STORE:RLIMit <string>
----------------	--------------------------------

Instruction	This command saves the ripple limit table of the active trace of the active channel into a file in the CSV format (extension ".csv"). If a file with the same name as the specified file name exists, its contents are overwritten.
Parameter Type	String
Parameter Range	255 characters or less
Return	None
Default	None
Menu	Math > Analysis > Limit > Ripple > Save Table
Example	:MMEMory:STORE:RLIMit "local/test.csv"

3.8.8 Load Segment Sweep Table (:MMEMory:LOAD:SEGMENT)

Command Format	:MMEMory:LOAD:SEGMENT <string>
Instruction	This command recalls the specified segment sweep table file, as the segment sweep table of the active channel.
Parameter Type	String
Parameter Range	255 characters or less
Return	None
Default	None
Menu	Sweep > Segment Table > Load Table
Example	:MMEMory:LOAD:SEGMENT "local/test.csv"

3.8.9 Save Segment Sweep Table (:MMEMory:STORE:SEGMENT)

Command Format	:MMEMory:STORE:SEGMENT <string>
Instruction	This command saves the segment sweep table of the active channel into a file in the CSV format (extension ".csv"). If a file with the same name as the specified file name exists, its contents are overwritten.
Parameter Type	String
Parameter Range	255 characters or less
Return	None
Default	None
Menu	Sweep > Segment Table > Save Table
Example	:MMEMory:STORE:SEGMENT "local/test.csv"

3.8.10 Load Instrument State (:MMEMory:LOAD[:STATE])

Command Format	:MMEMory:LOAD[:STATE] <string>
Instruction	This command recalls the specified instrument state file.

Parameter Type	String
Parameter Range	255 characters or less
Return	None
Default	None
Menu	Recall > Recall State
Example	:MMEMory:LOAD "local/test.sta"

3.8.11 Save Instrument State (:MMEMory:STORE[:STATe])

Command Format	:MMEMory:STORE[:STATe] <string>
Instruction	This command saves the instrument state into a file (file with the .sta extension). If a file with the same name as the specified file name exists, its contents are overwritten.
Parameter Type	String
Parameter Range	255 characters or less
Return	None
Default	None
Menu	Sweep > Segment Table > Save Table
Example	:MMEMory:STORE "local/test.sta"

3.8.12 Create Directory (:MMEMory:MDIRectory)

Command Format	:MMEMory:MDIRectory <string>
Instruction	This command creates a new directory (folder).
Parameter Type	String
Parameter Range	255 characters or less
Return	None
Default	None
Menu	None
Example	:MMEMory:MDIRectory "local/test1"

3.8.13 Save Display Image On the LCD (:MMEMory:STORe:IMAGe)

Command Format	:MMEMory:STORe:IMAGe <string>
Instruction	This command saves the display image on the LCD display at the execution of the object into a file in the bitmap (extension ".bmp") or portable network graphics format (extension ".png") or JPEG file interchange format (extension ".jpg").
Parameter Type	String
Parameter Range	255 characters or less

Return	None
Default	None
Menu	None
Example	:MMEMory:STORe:IMAGe "local/test.bmp"

3.8.14 Store SNP File (:MMEMory:STORe:SNP[:DATA])

Command Format	:MMEMory:STORe:SNP[:DATA] <string>
Instruction	Saves the measurement data for the active channel into a file in the touchstone format. You need to specify a file format and file type before saving a file. The extension differs depending on file types. .s1p:When specifying one port .s2p:When specifying two port .s3p:When specifying three port .s4p:When specifying four port
Parameter Type	String
Parameter Range	255 characters or less
Return	None
Default	None
Menu	Save Recall > Save Other > Save SnP
Example	:MMEMory:STORe:SNP:TYPE:S2P 2,3 :MMEMory:STORe:SNP "local/test.s2p"

3.8.15 Format of SNP File (:MMEMory:STORe:SNP:FORMat)

Command Format	:MMEMory:STORe:SNP:FORMat {AUTO MA DB RI} :MMEMory:STORe:SNP:FORMat?
Instruction	This command sets/gets the data format for saving measurement data for the active channel into a file in the touchstone format.
Parameter Type	String
Parameter Range	"AUTO":Specifies data format automatically according to the display format of the active trace. "MA":Specifies data format "log magnitude > angle". "DB":Specifies data format "linear magnitude > angle". "RI":Specifies data format "real part > imaginary part".
Return	String
Default	AUTO
Menu	Save Recall > Save Other > SnP Format
Example	:MMEMory:STORe:SNP:FORMat MA :MMEMory:STORe:SNP:FORMat? Return: MA

3.8.16 Port Saved in S1P File (:MMEMory:STORe:SNP:TYPE:S1P)

Command Format	:MMEMory:STORe:SNP:TYPE:S1P <numeric> :MMEMory:STORe:SNP:TYPE:S1P?
Instruction	This command sets/gets the specified port to the file type (1 port) when saving measurement data for the active channel into a file in the touchstone format.

Parameter Type	Integer
Parameter Range	1 ~ 4
Return	Integer
Default	1
Menu	None
Example	:MMEMory:STORe:SNP:TYPE:S1P 2 :MMEMory:STORe:SNP:TYPE:S1P? Return: 2

3.8.17 Ports Saved in S2P File (:MMEMory:STORe:SNP:TYPE:S2P)

Command Format	:MMEMory:STORe:SNP:TYPE:S2P <numeric1>,<numeric2> :MMEMory:STORe:SNP:TYPE:S2P?
Instruction	This command sets/gets the specified port to the file type (2 port) when saving measurement data for the active channel into a file in the touchstone format.
Parameter Type	Data array
Parameter Range	1 ~ 4
Return	Data array
Default	1,2
Menu	None
Example	:MMEMory:STORe:SNP:TYPE:S2P 2,3 :MMEMory:STORe:SNP:TYPE:S2P? Return: 2,3

3.8.18 Ports Saved in S3P File (:MMEMory:STORe:SNP:TYPE:S3P)

Command Format	:MMEMory:STORe:SNP:TYPE:S3P <numeric1>,<numeric2>,<numeric3> :MMEMory:STORe:SNP:TYPE:S3P?
Instruction	This command sets/gets the specified port to the file type (3 port) when saving measurement data for the active channel into a file in the touchstone format.
Parameter Type	Data array
Parameter Range	1 ~ 4
Return	Data array
Default	1,2,3
Menu	None
Example	:MMEMory:STORe:SNP:TYPE:S3P 2,3,4 :MMEMory:STORe:SNP:TYPE:S3P? Return: 2,3,4

3.8.19 Ports Saved in S4P File (:MMEMory:STORe:SNP:TYPE:S4P)

Command Format	:MMEMory:STORe:SNP:TYPE:S4P <numeric1>,<numeric2>,<numeric3>,<numeric4> :MMEMory:STORe:SNP:TYPE:S4P?
----------------	---

Instruction	This command sets/gets the specified port to the file type (4 port) when saving measurement data for the active channel into a file in the touchstone format.
Parameter Type	Data array
Parameter Range	1 ~ 4
Return	Data array
Default	1,2,3,4
Menu	None
Example	:MMEMory:STORe:SNP:TYPE:S4P 1,2,3,4 :MMEMory:STORe:SNP:TYPE:S4P? Return: 1,2,3,4

3.9 Service Subsystem

3.9.1 Get Active Trace (:SERVice:CHANnel{[1]-200}:TRACe:ACTive?)

Command Format	:SERVice:CHANnel{[1]-200}:TRACe:ACTive?
Instruction	This command reads the active trace number of selected channel.
Parameter Type	None
Parameter Range	None
Return	Integer
Default	1
Menu	None
Example	:SERVice:CHANnel1:TRACe:ACTive?

3.9.2 Get Active Channel (:SERVice:CHANnel:ACTive?)

Command Format	:SERVice:CHANnel:ACTive?
Instruction	This command reads the active channel number.
Parameter Type	None
Parameter Range	None
Return	Integer
Default	1
Menu	None
Example	:DISPlay:WINDow2:ACTivate :SERVice:CHANnel:ACTive? Return: 2

3.9.3 Get Upper Limit of Numbers of Channels (:SERVice:CHANnel:COUNt?)

Command Format	:SERVice:CHANnel:COUNt?
Instruction	This reads the upper limit of the number of channels.
Parameter Type	None
Parameter Range	None
Return	Integer
Default	None
Menu	None
Example	:SERVice:CHANnel:COUNt? Return: 256

3.9.4 Get Upper Limit of Numbers of Traces (:SERVice:CHANnel:TRACe:COUNT?)

Command Format	:SERVice:CHANnel:TRACe:COUNT?
Instruction	This reads the upper limit of the number of traces.
Parameter Type	None
Parameter Range	None
Return	Integer
Default	None
Menu	None
Example	:SERVice:CHANnel:TRACe:COUNT? Return: 256

3.9.5 Get Upper Limit of Numbers of Ports (:SERVice:PORT:COUNT?)

Command Format	:SERVice:PORT:COUNT?
Instruction	This reads the upper limit of the number of ports.
Parameter Type	None
Parameter Range	None
Return	Integer
Default	None
Menu	None
Example	:SERVice:PORT:COUNT?

3.9.6 Maximum Frequency (:SERVice:SWEep:FREQency:MAXimum?)

Command Format	:SERVice:SWEep:FREQency:MAXimum?
Instruction	This reads the upper limit of measurement frequency.
Parameter Type	None
Parameter Range	None
Return	Float, unit: Hz
Default	8.5 GHz
Menu	None
Example	:SERVice:SWEep:FREQency:MAXimum?

3.9.7 Minimum Frequency (:SERVice:SWEep:FREQency:MINimum?)

Command Format	:SERVice:SWEep:FREQency:MINimum?
Instruction	This reads the lower limit of measurement frequency.
Parameter Type	None
Parameter Range	None
Return	Float, unit: Hz
Default	9 kHz
Menu	None
Example	:SERVice:SWEep:FREQency:MINimum?

3.9.8 Get Upper Limit of Numbers of Sweep Points (:SERVice:SWEep:POINts?)

Command Format	:SERVice:SWEep:POINts?
Instruction	This reads the upper limit of the number of sweep points.
Parameter Type	None
Parameter Range	None
Return	Integer
Default	20001
Menu	None
Example	:SERVice:SWEep:POINts?

3.9.9 Clear Log Data (:SERVice:LOGGing:CLEar)

Command Format	:SERVice:LOGGing:CLEar
Instruction	This command clears the log data of the instrument.
Parameter Type	None
Parameter Range	None
Return	None
Default	None
Menu	None
Example	:SERVice:LOGGing:CLEar

3.10 Source Subsystem

3.10.1 Power Level (:SOURce{[1]-200}:POWER[:LEVel][:IMMediate][:AMPLitude])

Command Format	:SOURce{[1]-200}:POWER[:LEVel][:IMMediate][:AMPLitude] <numeric> :SOURce{[1]-200}:POWER[:LEVel][:IMMediate][:AMPLitude]?
Instruction	This command sets/gets the power level of the selected channel.
Parameter Type	Float, unit: dBm
Parameter Range	None
Return	Float, unit: dBm
Default	0
Menu	Power > Power Level
Example	:SOURce1:POWER -5 :SOURce1:POWER? Return: -5

3.10.2 Power Slope (:SOURce{[1]-200}:POWER[:LEVel]:SLOPe[:DATA])

Command Format	:SOURce{[1]-200}:POWER[:LEVel]:SLOPe[:DATA] <numeric> :SOURce{[1]-200}:POWER[:LEVel]:SLOPe[:DATA]?
Instruction	This command sets/gets the correction value of the power slope feature of channels 1 to 200.
Parameter Type	Float, unit: dB
Parameter Range	-2dB~2dB
Return	Float, unit: dB
Default	0
Menu	Power > Leveling&Offsets > Slope
Example	:SOURce1:POWER:SLOPe -1 :SOURce1:POWER:SLOPe? Return: -1

3.10.3 Power Slope State (:SOURce{[1]-200}:POWER[:LEVel]:SLOPe:STATe)

Command Format	:SOURce{[1]-200}:POWER[:LEVel]:SLOPe:STATe {ON OFF 1 0} :SOURce{[1]-200}:POWER[:LEVel]:SLOPe:STATe?
Instruction	This command turns ON/OFF or gets the status of the power slope feature, for the selected channel. This command corrects the attenuation of simple power level proportional to the frequency (attenuation due to cables etc).
Parameter Type	Boolean
Parameter Range	ON OFF 1 0
Return	Boolean
Default	OFF

Menu	Power > Leveling&Offsets > Slope Enable
Example	:SOURce1:POWer:SLOPe:STATe ON :SOURce1:POWer:SLOPe:STATe? Return: 1

3.10.4 Take Cal Sweep (:SOURce{[1]-200}:POWer:PORT{[1]|2|3|4}:CORRection:COLLect[:ACQuire])

Command Format	:SOURce{[1]-200}:POWer:PORT{[1] 2 3 4}:CORRection:COLLect[:ACQuire]
Instruction	This command excute the power calibration of select port. When the measurement is complete successfully, the power level error correction is automatically turned ON.
Parameter Type	None
Parameter Range	None
Return	None
Default	None
Menu	Cal > Power Cal > Take Cal Sweep
Example	:SOURce1:POWer:PORT2:CORRection:COLLect

3.10.5 Max Iteratin Count (:SOURce{[1]-200}:POWer:PORT{[1]|2}:CORRection:COLLect:ITERation[:COUNt])

Command Format	:SOURce{[1]-200}:POWer:PORT{[1] 2}:CORRection:COLLect:ITERation[:COUNt] <numeric> :SOURce{[1]-200}:POWer:PORT{[1] 2}:CORRection:COLLect:ITERation[:COUNt]?
Instruction	This command sets/gets the maximum number of readings to take at each source power data point for the selected port and channel.
Parameter Type	Interger
Parameter Range	0~50
Return	Interger
Default	0
Menu	Cal > Power Cal > Max Iteration
Example	:SOURce1:POWer:PORT2:CORRection:COLLect:ITERation 10 :SOURce1:POWer:PORT2:CORRection:COLLect:ITERation? Return: 10

3.10.6 Num of Readings (:SOURce{[1]-200}:POWer:PORT{[1]|2|3|4}:CORRection:COLLect:AVERage[:COUNt])

Command Format	:SOURce{[1]-200}:POWer:PORT{[1] 2 3 4}:CORRection:COLLect:AVERage[:COUNt] <numeric> :SOURce{[1]-200}:POWer:PORT{[1] 2 3 4}:CORRection:COLLect:AVERage[:COUNt]?
Instruction	This command sets/gets the number of power calibration data measurements per measurement point for the selected port of selected channel.

Parameter Type	Integer
Parameter Range	1~50
Return	Integer
Default	1
Menu	Cal > Power Cal > Num of Readings
Example	:SOURce1:POWer:PORT2:CORRection:COLLect:AVERAge 5 :SOURce1:POWer:PORT2:CORRection:COLLect:AVERAge? Return: 5

3.10.7 Loss Compensation State (:SOURce{[1]-200}:POWer:PORT{[1]|2|3|4}:CORRection:COLLect:TABLE:LOSS[:STATE])

Command Format	:SOURce{[1]-200}:POWer:PORT{[1] 2 3 4}:CORRection:COLLect:TABLE:LOSS[:STATE] {ON OFF 1 0} :SOURce{[1]-200}:POWer:PORT{[1] 2 3 4}:CORRection:COLLect:TABLE:LOSS[:STATE]?
Instruction	This command turns ON/OFF or returns the status of the loss compensation, for the selected port of selected channel.
Parameter Type	Boolean
Parameter Range	ON OFF 1 0
Return	Boolean
Default	OFF
Menu	Cal > Power Cal > Loss Compens Off > Power Loss Compensation > Compensation On
Example	:SOURce1:POWer:PORT2:CORRection:COLLect:TABLE:LOSS ON :SOURce1:POWer:PORT2:CORRection:COLLect:TABLE:LOSS? Return: 1

3.10.8 Loss Compensation Data (:SOURce{[1]-200}:POWer:PORT{[1]|2|3|4}:CORRection:COLLect:TABLE:LOSS:DATA)

Command Format	:SOURce{[1]-200}:POWer:PORT{[1] 2 3 4}:CORRection:COLLect:TABLE:LOSS:DATA <numeric 1>, ..., <numeric 1+(Nx2)> :SOURce{[1]-200}:POWer:PORT{[1] 2 3 4}:CORRection:COLLect:TABLE:LOSS:DATA?
Instruction	This command sets/gets the loss compensation table, for the selected port of selected channel.
Parameter Type	Data array
Parameter Range	Indicates the array data (for the loss compensation table) of 1 + Num (number of set data items)X2. Where n is an integer between 1 and Num. <ul style="list-style-type: none"> • Data(0): The number of data items you want to set. Specify an integer between 0 to 100. When you set the number of data items to 0 (to clear the loss compensation table), you specify only Data(0) as the Data variable. • Data(nX2-1): The frequency of the n-th data item (1 kHz to 500 GHz).

	<ul style="list-style-type: none"> • Data(nX2): The loss of the n-th data item (-100 dB to 100 dB). The index of the array starts from 0.
Return	Data array
Default	None
Menu	Cal > Power Cal > Loss Compen Off > Power Loss Compensation
Example	:SOURce1:POWer:PORT2:CORRection:COLLect:TABLE:LOSS:DATA 2,2e9,3,5e9,-0.5 :SOURce1:POWer:PORT2:CORRection:COLLect:TABLE:LOSS:DATA? Return: 2,2e+09,3,5e+09,-0.5

3.10.9 Power Calibration Correction State (:SOURce{[1]-200}:POWer:PORT{[1]|2|3|4}:CORRection[:STATe])

Command Format	:SOURce{[1]-200}:POWer:PORT{[1] 2 3 4}:CORRection[:STATe] {ON OFF 1 0} :SOURce{[1]-200}:POWer:PORT{[1] 2 3 4}:CORRection[:STATe]?
Instruction	This command turns ON/OFF or returns the status of the power level error correction, for the selected port of the selected channel.
Parameter Type	Boolean
Parameter Range	ON OFF 1 0
Return	Boolean
Default	OFF
Menu	Cal > Power Correction
Example	:SOURce1:POWer:PORT1:CORRection ON :SOURce1:POWer:PORT1:CORRection? Return: 1

3.10.10 Power Calibration Correction Data (:SOURce{[1]-200}:POWer:PORT{[1]|2|3|4}:CORRection:DATA)

Command Format	:SOURce{[1]-200}:POWer:PORT{[1] 2 3 4}:CORRection:DATA <numeric 1>, ..., <numeric NOP> :SOURce{[1]-200}:POWer:PORT{[1] 2 3 4}:CORRection:DATA?
Instruction	This command sets/gets the power calibration data array, for the selected port of selected channel.
Parameter Type	Data array
Parameter Range	Indicates the array data (power calibration data array) of NOP (number of points). Where n is an integer between 1 and NOP. <ul style="list-style-type: none"> • Data(n-1): Data at the n-th measurement point The index of the array starts from 0.
Return	Data array
Default	None
Menu	None
Example	:SENSe1:SWEEp:POINts 5 :SOURce1:POWer:PORT2:CORRection:DATA 1,2,3,4,5 :SOURce1:POWer:PORT2:CORRection:DATA? Return: 1,2,3,4,5

3.10.11 Power Level of Port (:SOURce{[1]-200}:POWER:PORT{[1]|2|3|4}[:LEVel][:IMMediate][:AMPLitude])

Command Format	:SOURce{[1]-200}:POWER:PORT{[1] 2 3 4} [:LEVel][:IMMediate][:AMPLitude] <numeric> :SOURce{[1]-200}:POWER:PORT{[1] 2 3 4} [:LEVel][:IMMediate][:AMPLitude]?
Instruction	This command sets/gets the power level, for the selected port of the selected channel.
Parameter Type	Float, unit: dBm
Parameter Range	None
Return	Float, unit: dBm
Default	0
Menu	Power > Port Power > Power Level
Example	:SOURce1:POWER:PORT1 -5 :SOURce1:POWER:PORT1? Return: -5

3.10.12 Power Level Couple State (:SOURce{[1]-200}:POWER:PORT:COUPlE)

Command Format	:SOURce{[1]-200}:POWER:PORT:COUPlE {ON OFF 1 0} :SOURce{[1]-200}:POWER:PORT:COUPlE?
Instruction	This command sets/gets whether to output the same power level for each port of channels 1 to 200.
Parameter Type	Boolean
Parameter Range	ON OFF 1 0
Return	Boolean
Default	ON
Menu	Power > Port Power > Coupling
Example	:SOURce1:POWER:PORT:COUPlE OFF :SOURce1:POWER:PORT:COUPlE? Return: 0

3.10.13 Power Start (:SOURce{[1]-200}:POWER:STARt)

Command Format	:SOURce{[1]-200}:POWER:STARt <numeric> :SOURce{[1]-200}:POWER:STARt?
Instruction	This command sets/gets the start value of the sweep range for the power sweep for channels 1 to 200.
Parameter Type	Float, unit: dBm
Parameter Range	None
Return	Float, unit: dBm
Default	-10
Menu	Power > Port Power > Start Power
Example	:SOURce1:POWER:STARt 5 :SOURce1:POWER:STARt? Return: 5

3.10.14 Power Stop (:SOURce{[1]-200}:POWer:STOP)

Command Format	:SOURce{[1]-200}:POWer:STOP <numeric> :SOURce{[1]-200}:POWer:STOP?
Instruction	This command sets/gets the stop value of the sweep range for the power sweep for channels 1 to 200.
Parameter Type	Float, unit: dBm
Parameter Range	None
Return	Float, unit: dBm
Default	0
Menu	Power > Port Power > Stop Power
Example	:SOURce1:POWer:STOP -5 :SOURce1:POWer:STOP? Return: -5

3.11 System Subsystem

3.11.1 State of Backlight (:SYSTem:BACKlight)

Command Format	:SYSTem:BACKlight {ON OFF 1 0} :SYSTem:BACKlight?
Instruction	This command turns ON/OFF or returns the status of the backlight of the LCD display.
Parameter Type	Boolean
Parameter Range	ON OFF 1 0
Return	Boolean
Default	1
Menu	None
Example	:SYSTem:BACKlight OFF :SYSTem:BACKlight? Return: 0

3.11.2 Complete Buzzer (:SYSTem:BEEPer:COMplete:IMMediate)

Command Format	:SYSTem:BEEPer:COMplete:IMMediate
Instruction	This command generates a beep for the notification of the completion of an operation.
Parameter Type	None
Parameter Range	None
Return	None
Default	None
Menu	System > Buzzer > Complete Test
Example	:SYSTem:BEEPer:COMplete:IMMediate

3.11.3 Complete Buzzer State (:SYSTem:BEEPer:COMplete:STATE)

Command Format	:SYSTem:BEEPer:COMplete:STATE {ON OFF 1 0} :SYSTem:BEEPer:COMplete:STATE?
Instruction	This command turns ON/OFF or returns the status of the beeper for the notification of the completion of the operation.
Parameter Type	Boolean
Parameter Range	ON OFF 1 0
Return	Boolean
Default	ON
Menu	System > Buzzer > Complete Buzzer
Example	:SYSTem:BEEPer:COMplete:STATE OFF :SYSTem:BEEPer:COMplete:STATE? Return: 0

3.11.4 Warning Buzzer (:SYSTem:BEEPer:WARNIng:IMMediate)

Command Format	:SYSTem:BEEPer:WARNIng:IMMediate
Instruction	This command generates a beep for the notification of warning/limit test results.
Parameter Type	None
Parameter Range	None
Return	None
Default	None
Menu	System > Buzzer > Warning Test
Example	:SYSTem:BEEPer:WARNIng:IMMediate

3.11.5 Warning Buzzer State (:SYSTem:BEEPer:WARNIng:STATe)

Command Format	:SYSTem:BEEPer:WARNIng:STATe {ON OFF 1 0} :SYSTem:BEEPer:WARNIng:STATe?
Instruction	This command turns ON/OFF or returns the status of the beeper for the notification of warning/limit test results.
Parameter Type	Boolean
Parameter Range	ON OFF 1 0
Return	Boolean
Default	ON
Menu	System > Buzzer > Warning Buzzer
Example	:SYSTem:BEEPer:WARNIng:STATe ON :SYSTem:BEEPer:WARNIng:STATe? Return: 1

3.11.6 Information About Power Meter (:SYSTem:COMMunicate:USB:PMETer:CATalog?)

Command Format	:SYSTem:COMMunicate:USB:PMETer:CATalog?
Instruction	This command reads the identification information string of power meters.
Parameter Type	None
Parameter Range	None
Return	Returns identification information about connected power meters.
Default	None
Menu	None
Example	:SYSTem:COMMunicate:USB:PMETer:CATalog?

3.11.7 System Date (:SYSTem:DATE)

Command Format	:SYSTem:DATE <String> :SYSTem:DATE?
Instruction	This command sets/gets the date of the clock built in the VNA instrument.
Parameter Type	Data array
Parameter Range	Indicates 3-element array data (date of the built-in clock). Data(0) Sets year(1980~2099). Data(1) Sets month(1~12). Data(2) Sets day(1~31). The index of the array starts from 0.
Return	Data array
Default	None
Menu	System > Date & Time
Example	:SYSTem:DATE 2020,1,1 :SYSTem:DATE? Return: 2020,01,01

3.11.8 System Time (:SYSTem:TIME)

Command Format	:SYSTem:TIME <String> :SYSTem:TIME?
Instruction	This command sets/gets the time of the clock built in the VNA instrument.
Parameter Type	Data array
Parameter Range	Indicates 3-element array data (date of the built-in clock). Data(0) Sets hour(0~23). Data(1) Sets minute(0~59). Data(2) Sets second(0~59). The index of the array starts from 0.
Return	Data array
Default	None
Menu	System > Date & Time
Example	:SYSTem:TIME 10,30,40 :SYSTem:TIME? Return: 10,30,40

3.11.9 Default Preset (:SYSTem:PRESet)

Command Format	:SYSTem:PRESet
Instruction	This command presets the setting state of the VNA to the original factory setting.
Parameter Type	None
Parameter Range	None
Return	None
Default	None
Menu	System > Preset > Preset Option is "Default", and at the same time execute: System > Preset > Preset
Example	:SYSTem:PRESet

3.11.10 Preset Option (:SYSTem:PRESet:TYPE)

Command Format	:SYSTem:PRESet:TYPE {DEFault LAST USER}
Instruction	This command sets/gets the system preset type.
Parameter Type	Enumeration
Parameter Range	DEFault LAST USER
Return	Enumeration
Default	None
Menu	Preset > Preset Option
Example	:SYSTem:PRESET:TYPE USER :SYSTem:PRESET:TYPE? Return: USER

3.11.11 User Preset (:SYSTem:UPReset)

Command Format	:SYSTem:UPReset
Instruction	This command presets the VNA with the user settings. The command is executed regardless of the operation mode in preset state. If you try to specify a file for a preset (local:/user_preset.sta) that does not exist, an error will occur and this command will be ignored.
Parameter Type	None
Parameter Range	None
Return	None
Default	None
Menu	System > Preset > Preset Option is "User", and at the same time execute: System > Preset > Preset
Example	:SYSTem:UPReset

3.11.12 Load User Preset File (:SYSTem:UPReset:LOAD[:FILE])

Command Format	:SYSTem:UPReset:LOAD[:FILE] <String>
Instruction	This command loads an existing instrument state file (.sta or .csa) to be used for User Preset.
Parameter Type	String
Parameter Range	None
Return	None
Default	None
Menu	None
Example	SYSTem:UPReset:LOAD "local/user_preset.sta"

3.11.13 Last Preset (:SYSTem:LPRreset)

Command Format	:SYSTem:LPRreset
Instruction	This command presets the setting state of VNA to the settings before the last software shutdown.
Parameter Type	None
Parameter Range	None
Return	None
Default	None
Menu	System > Preset > Preset Option is "Last", and at the same time execute: System > Preset > Preset
Example	:SYSTem:LPRreset

3.11.14 Power On Line State (:SYSTem:PONLine[:STATe])

Command Format	:SYSTem:PONLine[:STATe] {ON OFF 1 0} :SYSTem:PONLine[:STATe]?
Instruction	This command turns ON/OFF or returns the status of the system power on line state.
Parameter Type	Boolean
Parameter Range	ON OFF 1 0
Return	Boolean
Default	OFF
Menu	Preset > Power On Line
Example	:SYSTem:PONLine ON :SYSTem:PONLine? Return: 1

3.11.15 Power On Option (:SYSTem:PON:TYPE)

Command Format	:SYSTem:PON:TYPE {DEFault LAST USER} :SYSTem:PON:TYPE?
Instruction	This command sets/gets the system start type after power on.
Parameter Type	Enumeration
Parameter Range	DEFault LAST USER
Return	Enumeration
Default	DEFault
Menu	Preset > Power On Option
Example	:SYSTem:PON:TYPE USER :SYSTem:PON:TYPE? Return: USER

3.11.16 Factory Reset (:SYSTem:FDEFault)

Command Format	:SYSTem:FDEFault
----------------	------------------

Instruction	This command reset the system status return to factory state.
Parameter Type	None
Parameter Range	None
Return	None
Default	None
Menu	Preset > Factory Reset
Example	:SYSTem:FDEFault

3.11.17 GPIB Address (:SYSTem:COMMunicate:GPIB:ADDRESS)

Command Format	:SYSTem:COMMunicate:GPIB:ADDRESS <numeric> :SYSTem:COMMunicate:GPIB:ADDRESS?
Instruction	Sets/gets the gpib address for the network analyzer.
Parameter Type	Integer
Parameter Range	1~30
Return	Integer
Default	18
Menu	System > GPIB
Example	:SYSTem:COMMunicate:GPIB:ADDRESS 7 :SYSTem:COMMunicate:GPIB:ADDRESS? Return: 7

3.11.18 State of DHCP (:SYSTem:COMMunicate:LAN:TYPE)

Command Format	:SYSTem:COMMunicate:LAN:TYPE {STATIC DHCP} :SYSTem:COMMunicate:LAN:TYPE?
Instruction	Toggles the IP assignment setting between static (manual) and DHCP (dynamic assignment) mode. Gets IP config.
Parameter Type	Enumeration
Parameter Range	STATIC DHCP
Return	Enumeration
Default	STATIC
Menu	System > LAN Status > DHCP
Example	:SYSTem:COMMunicate:LAN:TYPE DHCP :SYSTem:COMMunicate:LAN:TYPE? Return: DHCP

3.11.19 IP Address (:SYSTem:COMMunicate:LAN:IPADDRESS)

Command Format	:SYSTem:COMMunicate:LAN:IPADdress <"xxx.xxx.xxx.xxx"> :SYSTem:COMMunicate:LAN:IPADdress?
Instruction	Sets a host name for the analyzer in network. Gets IP address.
Parameter Type	String
Parameter Range	Conform to the IP Sets standard (0-255:0-255:0-255:0-255).
Return	String
Default	None
Menu	System > LAN Status > IP Address
Example	:SYSTem:COMMunicate:LAN:IPADdress "10.11.13.100" :SYSTem:COMMunicate:LAN:IPADdress? Return: "10.11.13.100"

3.11.20 Subnet Mask (:SYSTem:COMMunicate:LAN:SMASk)

Command Format	:SYSTem:COMMunicate:LAN:SMASk <"xxx.xxx.xxx.xxx"> :SYSTem:COMMunicate:LAN:SMASk?
Instruction	Sets the subnet mask according to the PC network Settings. The subnet mask will be set automatically if the IP assignment is set to DHCP.
Parameter Type	String
Parameter Range	Conform to the IP Sets standard (0-255:0-255:0-255:0-255).
Return	String
Default	None
Menu	System > LAN Status > SUB Mask
Example	:SYSTem:COMMunicate:LAN:SMASk "255.255.255.0" :SYSTem:COMMunicate:LAN:SMASk? Return: "255.255.255.0"

3.11.21 Gateway (:SYSTem:COMMunicate:LAN:GATeway)

Command Format	:SYSTem:COMMunicate:LAN:GATeway <"xxx.xxx.xxx.xxx"> :SYSTem:COMMunicate:LAN:GATeway?
Instruction	Sets the gateway for the analyzer in the network. The gateway will be fetched automatically if the IP assignment is set to DHCP. Gets gateway.
Parameter Type	String
Parameter Range	Conform to the IP Sets standard (0-255:0-255:0-255:0-255).
Return	String
Default	None
Menu	System > LAN Status > Gateway
Example	:SYSTem:COMMunicate:LAN:GATeway "10.11.13.1" :SYSTem:COMMunicate:LAN:GATeway? Return: "10.11.13.1"

3.11.22 State of Power Limit (:SYSTem:POWer{[1]|2|3|4}:LIMit:STATe)

Command Format	:SYSTem:POWer{[1] 2 3 4}:LIMit:STATe {ON OFF 1 0} :SYSTem:POWer{[1] 2 3 4}:LIMit:STATe?
Instruction	This command enables or disables the power limit for the specified port.
Parameter Type	Boolean
Parameter Range	ON OFF 1 0
Return	Boolean
Default	OFF
Menu	Power > Leveling&Offsets > Limit Enable
Example	:SYSTem:POWer1:LIMit:STATe ON :SYSTem:POWer1:LIMit:STATe? Return: 1

3.11.23 Power Limit Value (:SYSTem:POWer{[1]|2|3|4}:LIMit)

Command Format	:SYSTem:POWer{[1] 2 3 4}:LIMit <numeric> :SYSTem:POWer{[1] 2 3 4}:LIMit?
Instruction	This command sets and gets the power limit value for the specified port.
Parameter Type	Float, unit: dB
Parameter Range	-1000~1000dB
Return	Float, unit: dB
Default	0
Menu	Power > Leveling&Offsets > Limit
Example	:SYSTem:POWer1:LIMit 10 :SYSTem:POWer1:LIMit? Return: 10

4. TDR Commands

4.1 Calculate Subsystem

4.1.1 Channel TDR State (:CALCulate:TDR:STATe)

Command Format	:CALCulate:TDR:STATe {ON OFF 1 0} :CALCulate:TDR:STATe?
Instruction	This command sets/gets TDR option enable state.
Parameter Type	Boolean
Parameter Range	ON OFF 1 0
Return	Boolean
Default	OFF
Menu	Math > TDR > TDR
Example	:CALC:TDR:STAT ON :CALC:TDR:STAT? Return: 1

4.1.2 Trace Allocation (:CALCulate:ALLocate)

Command Format	:CALCulate:ALLocate {SPARameters TPARameters MIXed}
Instruction	This command sets type of the parameter & format allocation for each trace.
Parameter Type	Enumeration
Parameter Range	SPARameters TPARameters MIXed
Return	None
Default	MIXed
Menu	TDR/TDT > Trace Control > Mixed/All T/All S
Example	:CALCulate:ALLocate SPAR

4.1.3 Select Trace (:CALCulate:ATRaces:ACTive)

Command Format	:CALCulate:ATRaces:ACTive <numeric> :CALCulate:ATRaces:ACTive?
Instruction	This command sets/gets active trace number.
Parameter Type	Integer
Parameter Range	None
Return	Integer
Default	None
Menu	TDR > Trace

Example	:CALC:ATR:ACT 6 :CALC:ATR:ACT? Return: 6
---------	--

4.1.4 Trace Count (:CALCulate:ATRaces:COUNT)

Command Format	:CALCulate:ATRaces:COUNT?
Instruction	This command returns the number of trace.
Parameter Type	None
Parameter Range	None
Return	Integer
Default	Depending on DUT topology setting
Menu	None
Example	:CALC:ATR:COUN?

4.1.5 Marker Coupling Enable (:CALCulate:ATRaces:MARKer:COUple)

Command Format	:CALCulate:ATRaces:MARKer:COUple {ON OFF 1 0} :CALCulate:ATRaces:MARKer:COUple?
Instruction	This command sets state for the marker couple mode.
Parameter Type	Boolean
Parameter Range	ON OFF 1 0
Return	Boolean
Default	ON
Menu	TDR/TDT > Trace Control > Coupling > Marker
Example	:CALC:ATR:MARK:COUP OFF :CALC:ATR:MARK:COUP? Return: 0

4.1.6 Time Coupling Enable (:CALCulate:ATRaces:TIME:COUple)

Command Format	:CALCulate:ATRaces:TIME:COUple {ON OFF 1 0} :CALCulate:ATRaces:TIME:COUple?
Instruction	This command sets state for the transform couple mode.
Parameter Type	Boolean
Parameter Range	ON OFF 1 0
Return	Boolean
Default	ON
Menu	TDR/TDT > Trace Control > Coupling > Time
Example	:CALC:ATR:TIME:COUP OFF :CALC:ATR:TIME:COUP?

	Return: 0
--	-----------

4.1.7 Time Stimulus Voltage (:CALCulate:ATRaces:TIME:STEP:AMPLitude)

Command Format	:CALCulate:ATRaces:TIME:STEP:AMPLitude <numeric> :CALCulate:ATRaces:TIME:STEP:AMPLitude?
Instruction	This command sets/gets step amplitude value for the transform function.
Parameter Type	Float, unit: V (Voltage)
Parameter Range	0.001~5
Return	Float, unit: V (Voltage)
Default	0.2
Menu	Setup > Basic > Stim. Ampl.
Example	:CALC:ATR:TIME:STEP:AMPL 0.5 :CALC:ATR:TIME:STEP:AMPL? Return: 0.5

4.1.8 DUT topology (:CALCulate:DEvice)

Command Format	:CALCulate:DEvice {SEND1 SEND2 DIF1 SEND4 DIF2} :CALCulate:DEvice?
Instruction	This command sets step amplitude value for the transform function.
Parameter Type	Enumeration
Parameter Range	SEND1 SEND2 DIF1 SEND4 DIF2
Return	Enumeration
Default	SEND1
Menu	Setup > Basic > DUT topology
Example	:CALC:DEV SEND2 :CALC:DEV? Return: SEND2

4.1.9 Port De-embedding S2P Filename (:CALCulate:EMBed:S2P:PORT{[1]|2|3|4}:DEEMbed:FILEname)

Command Format	:CALCulate:EMBed:S2P:PORT{[1] 2 3 4}:DEEMbed:FILEname <String> :CALCulate:EMBed:S2P:PORT{[1] 2 3 4}:DEEMbed:FILEname?
Instruction	This command sets/gets the filename of the S2P de-embedding user file. This file is saved as a 2-port touchstone file with the .s2p extension.
Parameter Type	String
Parameter Range	None
Return	String
Default	None
Menu	Setup > Adv Waveform > De-embedding > Load
Example	:CALC:EMB:S2P:PORT1:DEEM:FIL "local/file.s2p" :CALC:EMB:S2P:PORT1:DEEM:FIL?

	Return: local/file.s2p
--	------------------------

4.1.10 Port De-embedding Enable State (:CALCulate:EMBed:S2P:PORT{[1]|2|3|4}:DEEMbed:STATe)

Command Format	:CALCulate:EMBed:S2P:PORT{[1] 2 3 4}:DEEMbed:STATe {ON OFF 1 0} :CALCulate:EMBed:S2P:PORT{[1] 2 3 4}:DEEMbed:STATe?
Instruction	This command sets the S2P de-embedding function state ON/OFF. To turn ON, it is necessary to load the S2P file in advance.
Parameter Type	Boolean
Parameter Range	ON OFF 1 0
Return	Boolean
Default	OFF
Menu	Setup > Adv Waveform > De-embedding > Select De-embedding File > Enable
Example	:CALC:EMB:S2P:PORT1:DEEM:STAT ON :CALC:EMB:S2P:PORT1:DEEM:STAT? Return: 1

4.1.11 Diff Port De-embedding S4P Filename (:CALCulate:EMBed:S4P:DIFF{[1]|2}:FILename)

Command Format	:CALCulate:EMBed:S4P:DIFF{[1] 2}:FILename <String> :CALCulate:EMBed:S4P:DIFF{[1] 2}:FILename?
Instruction	This command sets the filename of the S4P de-embedding user file. This file is saved as a 4-port touchstone file with the .s4p extension.
Parameter Type	String
Parameter Range	None
Return	String
Default	None
Menu	Setup > Adv Waveform > De-embedding > Load
Example	:CALC:EMB:S4P:DIFF1:FIL "local/file.s4p" :CALC:EMB:S4P:DIFF1:FIL? Return: local/file.s4p

4.1.12 Diff Port De-embedding Enable State (:CALCulate:EMBed:S4P:DIFF{[1]|2}:STATe)

Command Format	:CALCulate:EMBed:S4P:DIFF{[1] 2}:STATe {ON OFF 1 0} :CALCulate:EMBed:S4P:DIFF{[1] 2}:STATe?
Instruction	This command sets the S4P de-embedding function state on/off.
Parameter Type	Boolean
Parameter Range	ON OFF 1 0
Return	Boolean
Default	OFF
Menu	Setup > Adv Waveform > De-embedding > Select De-embedding File > Enable

Example	:CALC:EMB:S4P:DIFF1:STAT ON :CALC:EMB:S4P:DIFF1:STAT? Return: 1
---------	---

4.1.13 De-embedding Enable State (:CALCulate:EMBed:STATE)

Command Format	:CALCulate:EMBed:STATe {ON OFF 1 0} :CALCulate:EMBed:STATe?
Instruction	This command sets the embed function state on/off.
Parameter Type	Boolean
Parameter Range	ON OFF 1 0
Return	Boolean
Default	OFF
Menu	Setup > Adv Waveform > De-embedding > Enable
Example	:CALC:EMB:STAT ON :CALC:EMB:STAT? Return: 1

4.1.14 Emphasis Post 2 Cursor (:CALCulate:EMPHasis:CURSor:POST2)

Command Format	:CALCulate:EMPHasis:CURSor:POST2 <numeric> :CALCulate:EMPHasis:CURSor:POST2?
Instruction	This command sets the emphasis post2 level.
Parameter Type	Float, unit: dB
Parameter Range	-20~20 dB
Return	Float, unit: dB
Default	0 dB
Menu	Setup > Adv Waveform > Emphasis > Post 2 Cursor
Example	:CALC:EMPH:CURS:POST2 3 :CALC:EMPH:CURS:POST2? Return: 3

4.1.15 Emphasis Post 1 Cursor (:CALCulate:EMPHasis:CURSor:POST1)

Command Format	:CALCulate:EMPHasis:CURSor:POST1 <numeric> :CALCulate:EMPHasis:CURSor:POST1?
Instruction	This command sets/gets the emphasis post1 level.
Parameter Type	Float, unit: dB
Parameter Range	-20~20 dB
Return	Float, unit: dB

Default	-3.5 dB
Menu	Setup > Adv Waveform > Emphasis > Post 1 Cursor
Example	:CALC:EMPH:CURS:POST1 3 :CALC:EMPH:CURS:POST1? Return: 3

4.1.16 Emphasis Pre Cursor (:CALCulate:EMPHasis:CURSor:PRE1)

Command Format	:CALCulate:EMPHasis:CURSor:PRE1 <numeric> :CALCulate:EMPHasis:CURSor:PRE1?
Instruction	This command sets the emphasis pre1 level.
Parameter Type	Float, unit: dB
Parameter Range	-20~20 dB
Return	Float, unit: dB
Default	0 dB
Menu	Setup > Adv Waveform > Emphasis > Pre Cursor
Example	:CALC:EMPH:CURS:PRE1 3 :CALC:EMPH:CURS:PRE1? Return: 3

4.1.17 Emphasis Enable (:CALCulate:EMPHasis:STATe)

Command Format	:CALCulate:EMPHasis:STATe {ON OFF 1 0} :CALCulate:EMPHasis:STATe?
Instruction	This command sets the emphasis function state on/off.
Parameter Type	Boolean
Parameter Range	ON OFF 1 0
Return	Boolean
Default	OFF
Menu	Setup > Adv Waveform > Emphasis > Enable
Example	:CALC:EMPH:STAT ON :CALC:EMPH:STAT? Return: 1

4.1.18 Equalization DC Gain (:CALCulate:EQUalization:CTLE:DC)

Command Format	:CALCulate:EQUalization:CTLE:DC <numeric> :CALCulate:EQUalization:CTLE:DC?
Instruction	This command sets the equalization CTLE (Continuous Time Linear Equalization) DC gain parameter.
Parameter Type	Float
Parameter Range	0~10
Return	Float

Default	0.667
Menu	Setup > Adv Waveform > Equalization > DC Gain
Example	:CALC:EQU:CTLE:DC 0.5 :CALC:EQU:CTLE:DC? Return: 0.5

4.1.19 Equalization Pole1 Frequency (:CALCulate:EQUalization:CTLE:POLE1)

Command Format	:CALCulate:EQUalization:CTLE:POLE1 <numeric> :CALCulate:EQUalization:CTLE:POLE1?
Instruction	This command sets the equalization CTLE (Continuous Time Linear Equalization) Pole1 parameter.
Parameter Type	Float, unit: Hz
Parameter Range	0~20GHz
Return	Float, unit: Hz
Default	1.95GHz
Menu	Setup > Adv Waveform > Equalization > Pole 1 Freq
Example	:CALC:EQU:CTLE:POLE1 2.5E9 :CALC:EQU:CTLE:POLE1? Return: 2500000000

4.1.20 Equalization Pole2 Frequency (:CALCulate:EQUalization:CTLE:POLE2)

Command Format	:CALCulate:EQUalization:CTLE:POLE2 <numeric> :CALCulate:EQUalization:CTLE:POLE2?
Instruction	This command sets the equalization CTLE (Continuous Time Linear Equalization) Pole2 parameter.
Parameter Type	Float, unit: Hz
Parameter Range	0~20GHz
Return	Float, unit: Hz
Default	5GHz
Menu	Setup > Adv Waveform > Equalization > Pole 2 Freq
Example	:CALC:EQU:CTLE:POLE2 3E9 :CALC:EQU:CTLE:POLE2? Return: 3000000000

4.1.21 Equalization Zero Frequency (:CALCulate:EQUalization:CTLE:POLE1)

Command Format	:CALCulate:EQUalization:CTLE:ZERO1 <numeric> :CALCulate:EQUalization:CTLE:ZERO1?
Instruction	This command sets the equalization CTLE (Continuous Time Linear Equalization) zero parameter.
Parameter Type	Float, unit: Hz

Parameter Range	0~20GHz
Return	Float, unit: Hz
Default	650MHz
Menu	Setup > Adv Waveform > Equalization > Zero Freq
Example	:CALC:EQU:CTLE:ZERO1 7.5E8 :CALC:EQU:CTLE:ZERO1? Return: 750000000

4.1.22 Equalizer User File (:CALCulate:EQUalization:FILENAME)

Command Format	:CALCulate:EQUalization:FILENAME <File> :CALCulate:EQUalization:FILENAME?
Instruction	This command sets the filename of the equalization equation user file.
Parameter Type	String
Parameter Range	None
Return	String
Default	None
Menu	Setup > Adv Waveform > Equalization > File > Load...
Example	:CALC:EQU:FILE "local/equalizer.csv" :CALC:EQU:FILE? Return: local/equalizer.csv

4.1.23 Equalization Enable (:CALCulate:EQUalization:STATE)

Command Format	:CALCulate:EQUalization:STATE {ON OFF 1 0} :CALCulate:EQUalization:STATE?
Instruction	This command sets the equalization function state on/off.
Parameter Type	Boolean
Parameter Range	ON OFF 1 0
Return	Boolean
Default	OFF
Menu	Setup > Adv Waveform > Equalization > Enable
Example	:CALC:EQU:STAT ON :CALC:EQU:STAT? Return: 1

4.1.24 Equalizer Type (:CALCulate:EQUalization:TYPE)

Command Format	:CALCulate:EQUalization:TYPE {EQUation USER} :CALCulate:EQUalization:TYPE?
Instruction	This command sets the equalization type.
Parameter Type	String

Parameter Range	EQUation USER
Return	String
Default	EQUation
Menu	Setup > Adv Waveform > Equalization > Type
Example	:CALC:EQU:TYPE USER :CALC:EQU:TYPE? Return: USER

4.1.25 Abort Eye Diagram Drawing (:CALCulate:EYE: ABORT)

Command Format	:CALCulate:EYE: ABORT
Instruction	This command aborts the calculation for the simulated eye diagram.
Parameter Type	None
Parameter Range	None
Return	None
Default	None
Menu	Eye/Mask > Trigger > Abort
Example	:CALC:EYE:ABOR

4.1.26 Draw Eye Diagram (:CALCulate:EYE:EXECute)

Command Format	:CALCulate:EYE:EXECute
Instruction	This command performs the calculation for the simulated eye diagram for the active trace.
Parameter Type	None
Parameter Range	None
Return	None
Default	None
Menu	Eye/Mask > Trigger > Draw Eye
Example	:CALC:EYE:EXEC

4.1.27 Bit Pattern Length (:CALCulate:EYE:INPut:BPATtern:LENGth)

Command Format	:CALCulate:EYE:INPut:BPATtern:LENGth <numeric> :CALCulate:EYE:INPut:BPATtern:LENGth?
Instruction	This command sets bits' power of 2 for PRBS pattern. This value is used only when the bit pattern type is selected at PRBS.
Parameter Type	Discrete
Parameter Range	3, 5, 7, 9, 11, 13, 15
Return	Discrete

Default	7
Menu	Eye/Mask > Stimulus > Length
Example	:CALC:EYE:INP:BPAT:LENG 3 :CALC:EYE:INP:BPAT:LENG? Return: 3

4.1.28 Bit Pattern Type (:CALCulate:EYE:INPut:BPATtern:TYPE)

Command Format	:CALCulate:EYE:INPut:BPATtern:TYPE {PRBS K285 USER STATistical} :CALCulate:EYE:INPut:BPATtern:TYPE?
Instruction	This command sets the bit pattern type for the simulated eye function.
Parameter Type	Enumeration
Parameter Range	PRBS K285 USER STATistical
Return	Enumeration
Default	PRBS
Menu	Eye/Mask > Stimulus > Type
Example	:CALC:EYE:INP:BPAT:TYPE K285 :CALC:EYE:INP:BPAT:TYPE? Return: K285

4.1.29 Input Data Rate (:CALCulate:EYE:INPut:DRATe)

Command Format	:CALCulate:EYE:INPut:DRATe <numeric> :CALCulate:EYE:INPut:DRATe?
Instruction	This command sets the bit rate for the simulated eye function.
Parameter Type	Float, unit: b/s (bits/second)
Parameter Range	100Mb/s ~ 2.4Gb/s
Return	Float, unit: b/s (bits/second)
Default	1Gb/s
Menu	Eye/Mask > Stimulus > Date Rate
Example	:CALC:EYE:INP:DRAT 1.2E9 :CALC:EYE:INP:DRAT? Return: 1200000000

4.1.30 Jitter Display Limit (:CALCulate:EYE:INPut:JITTer:DLIMit)

Command Format	:CALCulate:EYE:INPut:JITTer:DLIMit <numeric> :CALCulate:EYE:INPut:JITTer:DLIMit?
Instruction	This command sets/gets the display limit value.
Parameter Type	Float
Parameter Range	0~1
Return	Float

Default	1E-8
Menu	Eye/Mask > Advanced Waveform > Jitter > Display Limit
Example	:CALC:EYE:INP:JITT:DLIM 10E-10 :CALC:EYE:INP:JITT:DLIM? Return: 1e-09

4.1.31 Periodic Jitter Frequency (:CALCulate:EYE:INPut:JITTer:PERiodic:FREQuency)

Command Format	:CALCulate:EYE:INPut:JITTer:PERiodic:FREQuency <numeric> :CALCulate:EYE:INPut:JITTer:PERiodic:FREQuency?
Instruction	This command sets the periodic jitter frequency. This value is used only when periodic jitter function type is selected.
Parameter Type	Float, unit: Hz
Parameter Range	0~2MHz
Return	Float, unit: Hz
Default	500kHz
Menu	Eye/Mask > Advanced Waveform > Jitter > Periodic Jitter > Frequency
Example	:CALC:EYE:INP:JITT:PER:FREQ 10E3 :CALC:EYE:INP:JITT:PER:FREQ? Return: 10000

4.1.32 Periodic Jitter Magnitude (:CALCulate:EYE:INPut:JITTer:PERiodic:MAGNitude)

Command Format	:CALCulate:EYE:INPut:JITTer:PERiodic:MAGNitude <numeric> :CALCulate:EYE:INPut:JITTer:PERiodic:MAGNitude?
Instruction	This command sets the periodic jitter magnitude in peak-peak value. This value is used only when periodic jitter function type is selected.
Parameter Type	Float
Parameter Range	0~1 UI
Return	Float
Default	0
Menu	Eye/Mask > Advanced Waveform > Jitter > Periodic Jitter > Magnitude
Example	:CALC:EYE:INP:JITT:PER:MAGN 0.2 :CALC:EYE:INP:JITT:PER:MAGN? Return: 0.2

4.1.33 Random Jitter Magnitude (:CALCulate:EYE:INPut:JITTer:RANDom:MAGNitude)

Command Format	:CALCulate:EYE:INPut:JITTer:RANDom:MAGNitude <numeric> :CALCulate:EYE:INPut:JITTer:RANDom:MAGNitude?
Instruction	This command sets the random jitter magnitude in rms. This value is used only when random jitter function type is selected.
Parameter Type	Float

Parameter Range	0~0.25 UI
Return	Float
Default	0
Menu	Eye/Mask > Advanced Waveform > Jitter > Random Jitter > Magnitude(RMS)
Example	:CALC:EYE:INP:JITT:RAND:MAGN 0.2 :CALC:EYE:INP:JITT:RAND:MAGN? Return: 0.2

4.1.34 Jitter Enable (:CALCulate:EYE:INPut:JITTer:STATe)

Command Format	:CALCulate:EYE:INPut:JITTer:STATe {ON OFF 1 0} :CALCulate:EYE:INPut:JITTer:STATe?
Instruction	This command sets the jitter function state with simulated eye on/off.
Parameter Type	Boolean
Parameter Range	ON OFF 1 0
Return	Boolean
Default	OFF
Menu	Eye/Mask > Advanced Waveform > Jitter > Enable
Example	:CALC:EYE:INP:JITT:STAT ON :CALC:EYE:INP:JITT:STAT? Return: 1

4.1.35 Jitter Type (:CALCulate:EYE:INPut:JITTer:TYPE)

Command Format	:CALCulate:EYE:INPut:JITTer:TYPE {RANDom PERiodic} :CALCulate:EYE:INPut:JITTer:TYPE?
Instruction	This command sets the jitter function type for the simulated eye function.
Parameter Type	Enumeration
Parameter Range	RANDom PERiodic
Return	Enumeration
Default	PERiodic
Menu	Eye/Mask > Advanced Waveform > Jitter > Type > Random/Periodic
Example	:CALC:EYE:INP:JITT:TYPE RAND :CALC:EYE:INP:JITT:TYPE? Return: RAND

4.1.36 Input One Level (:CALCulate:EYE:INPut:OLEVel)

Command Format	:CALCulate:EYE:INPut:OLEVel <numeric> :CALCulate:EYE:INPut:OLEVel?
Instruction	This command sets the voltage level for bit "1" for the simulated eye function.
Parameter Type	Float, unit: V (Voltage)

Parameter Range	-5 ~ 5 V
Return	Float, unit: V (Voltage)
Default	0.2V
Menu	Eye/Mask > Stimulus > One Level
Example	:CALC:EYE:INP:OLEV -0.2 :CALC:EYE:INP:OLEV? Return: -0.2

4.1.37 Input Rise Time (:CALCulate:EYE:INPut:RTIME:DATA)

Command Format	:CALCulate:EYE:INPut:RTIME:DATA <numeric> :CALCulate:EYE:INPut:RTIME:DATA?
Instruction	This command sets the rise time value for the simulated eye function.
Parameter Type	Float, unit: s (second)
Parameter Range	Depending on input data rate.
Return	Float, unit: s (second)
Default	Depending on input data rate.
Menu	Eye/Mask > Stimulus > Rise Time
Example	:CALC:EYE:INP:RTIM:DATA 90e-12 :CALC:EYE:INP:RTIM:DATA? Return: 9e-11

4.1.38 Input Rise Time Type (:CALCulate:EYE:INPut:RTIME:THReshold)

Command Format	:CALCulate:EYE:INPut:RTIME:THReshold {T1_9 T2_8} :CALCulate:EYE:INPut:RTIME:THReshold?
Instruction	This command sets the rise time threshold for the simulated eye.
Parameter Type	Enumeration
Parameter Range	T1_9 T2_8
Return	Enumeration
Default	T1_9
Menu	Eye/Mask > Stimulus > Rise Time
Example	:CALC:EYE:INP:RTIM:THR T2_8 :CALC:EYE:INP:RTIM:THR? Return: T2_8

4.1.39 Input Zero Level (:CALCulate:EYE:INPut:ZLEVel)

Command Format	:CALCulate:EYE:INPut:ZLEVel <numeric> :CALCulate:EYE:INPut:ZLEVel?
Instruction	This command sets the voltage level for bit "0" for the simulated eye function.
Parameter Type	Float, unit: V (Voltage)

Parameter Range	-5 ~ 5 V
Return	Float, unit: V (Voltage)
Default	0 V
Menu	Eye/Mask > Stimulus > Zero Level
Example	:CALC:EYE:INP:ZLEV 0.5 :CALC:EYE:INP:ZLEV? Return: 0.5

4.1.40 Mask Test Result (:CALCulate:EYE:MASK:FAIL?)

Command Format	:CALCulate:EYE:MASK:FAIL?
Instruction	This command returns the mask test result.
Parameter Type	None
Parameter Range	None
Return	Boolean
Default	None
Menu	None
Example	:CALC:EYE:MASK:FAIL?

4.1.41 Mask Test Enable (:CALCulate:EYE:MASK:STATe)

Command Format	:CALCulate:EYE:MASK:STATe {ON OFF 1 0} :CALCulate:EYE:MASK:STATe?
Instruction	This command sets mask test with simulated eye on/off.
Parameter Type	Boolean
Parameter Range	ON OFF 1 0
Return	Boolean
Default	OFF
Menu	Eye/Mask > Scale/Mask > Mask Test
Example	:CALC:EYE:MASK:STAT ON :CALC:EYE:MASK:STAT? Return: 1

4.1.42 Eye Diagram Result Data (:CALCulate:EYE:RESuIts:DATA)

Command Format	:CALCulate:EYE:RESuIts:DATA?
Instruction	This command returns the results of eye measurement. The 18 values are returned. The minimum and maximum values are returned in addition of the displayed results (16 values) on the TDR application GUI.
Parameter Type	None

Parameter Range	None
Return	String
Default	None
Menu	Eye/Mask > Result
Example	:CALC:EYE:RES:DATA?

4.1.43 Eye Diagram Result Overlay (:CALCulate:EYE:RESults:DISPlay:STATe)

Command Format	:CALCulate:EYE:RESults:DISPlay:STATe {ON OFF 1 0} :CALCulate:EYE:RESults:DISPlay:STATe?
Instruction	This command turns the overlay on/off.
Parameter Type	Boolean
Parameter Range	ON OFF 1 0
Return	Boolean
Default	ON
Menu	Eye/Mask > Resul > Overlay
Example	:CALC:EYE:RES:DISP:STAT OFF :CALC:EYE:RES:DISP:STAT? Return: 0

4.1.44 Eye Diagram Result Rise Time Type (:CALCulate:EYE:RESults:THReshold)

Command Format	:CALCulate:EYE:RESults:THReshold {T1_9 T2_8} :CALCulate:EYE:RESults:THReshold?
Instruction	This command sets the rise time threshold level for the results of eye measurement.
Parameter Type	Enumeration
Parameter Range	T1_9 T2_8
Return	Enumeration
Default	T1_9
Menu	Eye/Mask > Resul > Rise Time Def.
Example	:CALC:EYE:RES:THR T2_8 :CALC:EYE:RES:THR? Return: T2_8

4.1.45 Eye Diagram Display Switch (:CALCulate:EYE:STATe)

Command Format	:CALCulate:EYE:STATe {ON OFF 1 0} :CALCulate:EYE:STATe?
Instruction	This command displays the EYE/MASK window.
Parameter Type	Boolean

Parameter Range	ON OFF 1 0
Return	Boolean
Default	OFF
Menu	None
Example	:CALC:EYE:STAT OFF :CALC:EYE:STAT?

4.1.46 Select Marker (:CALCulate:TRACe{Tr}:AMARkers:ACTIVE)

Command Format	:CALCulate:TRACe{Tr}:AMARkers:ACTIVE <numeric> :CALCulate:TRACe{Tr}:AMARkers:ACTIVE?
Instruction	This command sets active marker number.
Parameter Type	Integer
Parameter Range	None
Return	Integer
Default	None
Menu	TDR > Marker
Example	:CALC:TRAC1:AMAR:ACT 3 :CALC:TRAC1:AMAR:ACT? Return: 3

4.1.47 Peeling Enable (:CALCulate:TRACe{Tr}:CONVersion:PEELing:STATE)

Command Format	:CALCulate:TRACe{Tr}:CONVersion:PEELing:STATE {ON OFF 1 0} :CALCulate:TRACe{Tr}:CONVersion:PEELing:STATE?
Instruction	This command sets state for the peeling function.
Parameter Type	Boolean
Parameter Range	ON OFF 1 0
Return	Boolean
Default	OFF
Menu	TDR/TDT > Parameter > Peeling
Example	:CALC:TRAC1:CONV:PEEL:STAT ON :CALC:TRAC1:CONV:PEEL:STAT? Return: 1

4.1.48 Get Delta Time Search Result (:CALCulate:TRACe{Tr}:DTIME:DATA?)

Command Format	:CALCulate:TRACe{Tr}:DTIME:DATA?
Instruction	This command gets delta time result value. You can get the result even if Delta Time Search is off.

Parameter Type	None
Parameter Range	None
Return	Float, unit: s (second)
Default	None
Menu	None
Example	:CALC:TRAC1:DTIM:DATA?

4.1.49 Delta Time Search Position (:CALCulate:TRACe{Tr}:DTIME:POSition)

Command Format	:CALCulate:TRACe{Tr}:DTIME:POSition <numeric> :CALCulate:TRACe{Tr}:DTIME:POSition?
Instruction	This command sets delta time reference position.
Parameter Type	Float, unit: %
Parameter Range	0 ~ 100
Return	Float, unit: %
Default	50
Menu	TDR > ΔTime... > Position (%)
Example	:CALC:TRAC1:DTIM:POS 20 :CALC:TRAC1:DTIM:POS? Return: 20

4.1.50 Delta Time Search Enable (:CALCulate:TRACe{Tr}:DTIME:STATE)

Command Format	:CALCulate:TRACe{Tr}:DTIME:STATE {ON OFF 1 0} :CALCulate:TRACe{Tr}:DTIME:STATE?
Instruction	This command displays the delta time marker in the marker search.
Parameter Type	Boolean
Parameter Range	ON OFF 1 0
Return	Boolean
Default	OFF
Menu	TDR > ΔTime... > ΔTime Enable
Example	:CALC:TRAC1:DTIM:STAT ON :CALC:TRAC1:DTIM:STAT? Return: 1

4.1.51 Delta Time Search Target (:CALCulate:TRACe{Tr}:DTIME:TARGet)

Command Format	:CALCulate:TRACe{Tr}:DTIME:TARGet <numeric> :CALCulate:TRACe{Tr}:DTIME:TARGet?
Instruction	This command sets target trace number for the delta time function. The {Tr} is the trace number starting point for delta time.

	The <numeric> is the trace number stopping point for delta time.
Parameter Type	Integer
Parameter Range	None
Return	Integer
Default	Depending on the selected trace.
Menu	TDR > ΔTime... > Target(Stop)
Example	:CALC:TRAC1:DTIM:TARG 5 :CALC:TRAC1:DTIM:TARG? Return: 5

4.1.52 Trace Format (:CALCulate:TRACe{Tr}:FORMat)

Command Format	:CALCulate:TRACe{Tr}:FORMat {MLOGarithmic MLINear PHASe GDELay SCOMplex POLar SWR REAL IMAGinary UPHase PPHase ISMITH TLOGarithmic TLINear TREAL IMPedance VOLT} :CALCulate:TRACe{Tr}:FORMat?
Instruction	This command sets trace format.
Parameter Type	Enumeration
Parameter Range	MLOGarithmic MLINear PHASe GDELay SCOMplex POLar SWR REAL IMAGinary UPHase PPHase ISMITH TLOGarithmic TLINear TREAL IMPedance VOLT
Return	Enumeration
Default	Depending on the selected trace.
Menu	TDR/TDT > Parameters > Format
Example	:CALC:TRAC1:FORM VOLT :CALC:TRAC1:FORM? Return: VOLT

4.1.53 Gating Start (:CALCulate:TRACe{Tr}:GATE:STARt)

Command Format	:CALCulate:TRACe{Tr}:GATE:STARt <numeric> :CALCulate:TRACe{Tr}:GATE:STARt?
Instruction	This command sets start value for the gating function.
Parameter Type	Float, unit: s (second)
Parameter Range	None
Return	Float, unit: s (second)
Default	None
Menu	TDR/TDT > Gating > Start
Example	:CALC:TRAC1:GATE:STAR 2E-9 :CALC:TRAC1:GATE:STAR? Return: 2e-09

4.1.54 Gating Enable (:CALCulate:TRACe{Tr}:GATE:STATe)

Command Format	:CALCulate:TRACe{Tr}:GATE:STATe {ON OFF 1 0} :CALCulate:TRACe{Tr}:GATE:STATe?
Instruction	This command sets state for the gating function.
Parameter Type	Boolean
Parameter Range	ON OFF 1 0
Return	Boolean
Default	OFF
Menu	TDR/TDT > Gating > Gating
Example	:CALC:TRAC1:GATE:STAT ON :CALC:TRAC1:GATE:STAT? Return: 1

4.1.55 Gating Stop (:CALCulate:TRACe{Tr}:GATE:STOP)

Command Format	:CALCulate:TRACe{Tr}:GATE:STOP <numeric> :CALCulate:TRACe{Tr}:GATE:STOP?
Instruction	This command sets stop value for the gating function.
Parameter Type	Float, unit: s (second)
Parameter Range	None
Return	Float, unit: s (second)
Default	None
Menu	TDR/TDT > Gating > Stop
Example	:CALC:TRAC1:GATE:STOP 6E-9 :CALC:TRAC1:GATE:STOP? Return: 6e-09

4.1.56 Gating Type (:CALCulate:TRACe{Tr}:GATE:TYPE)

Command Format	:CALCulate:TRACe{Tr}:GATE:TYPE {BPASs NOTCh} :CALCulate:TRACe{Tr}:GATE:TYPE?
Instruction	This command sets gate type for the gating function.
Parameter Type	Enumeration
Parameter Range	BPASs NOTCh
Return	Enumeration
Default	BPASs
Menu	TDR/TDT > Gating > Type > Notch/Bandpass
Example	:CALC:TRAC1:GATE:TYPE NOTC :CALC:TRAC1:GATE:TYPE? Return: NOTC

4.1.57 Reference Marker Enable (:CALCulate:TRACe{Tr}:MARKer{Mk}:REFerence:STATe)

Command Format	:CALCulate:TRACe{Tr}:MARKer{Mk}:REFerence:STATe {ON OFF 1 0} :CALCulate:TRACe{Tr}:MARKer{Mk}:REFerence:STATe?
Instruction	This command sets state for the reference marker display.
Parameter Type	Boolean
Parameter Range	ON OFF 1 0
Return	Boolean
Default	OFF
Menu	TDR > Marker > Add Ref
Example	:CALC:TRAC1:MARK1:REF:STAT ON :CALC:TRAC1:MARK1:REF:STAT? Return: 1

4.1.58 Trace Measure Parameter (:CALCulate:TRACe{Tr}:PARAmeter)

Command Format	:CALCulate:TRACe{Tr}:PARAmeter {String} :CALCulate:TRACe{Tr}:PARAmeter?
Instruction	This command sets measurement parameter.
Parameter Type	String
Parameter Range	Txy Tddxy Tdcxy Tcdxy Tccxy Sxy Sddxy Sdcxy Scdxy Sccxy, x=1~4, y=1~4
Return	String
Default	Depending on the trace and DUT topology.
Menu	TDR/TDT > Parameter
Example	:CALC:TRAC2:PAR T11 :CALC:TRAC2:PAR? Return: T11

4.1.59 Stimulus Impulse Width (:CALCulate:TRACe{Tr}:TIME:IMPulse:WIDTh)

Command Format	:CALCulate:TRACe{Tr}:TIME:IMPulse:WIDTh <numeric> :CALCulate:TRACe{Tr}:TIME:IMPulse:WIDTh?
Instruction	This command sets impulse width value for the transform function.
Parameter Type	Float, unit: s (second)
Parameter Range	None
Return	Float, unit: s (second)
Default	None
Menu	TDR/TDT > Parameter > Impulse Width
Example	:CALC:TRAC1:TIME:IMP:WIDT 4.7E-11 :CALC:TRAC1:TIME:IMP:WIDT? Return: 7.09810588235294e-11

4.1.60 Stimulus Rise Time (:CALCulate:TRACe{Tr}:TIM

E:STEP:RTIME:DATA)

Command Format	:CALCulate:TRACe{Tr}:TIME:STEP:RTIME:DATA <numeric> :CALCulate:TRACe{Tr}:TIME:STEP:RTIME:DATA?
Instruction	This command sets rise time value for the transform function.
Parameter Type	Float, unit: s (second)
Parameter Range	None
Return	Float, unit: s (second)
Default	None
Menu	TDR/TDT > Parameter > Rise Time
Example	:CALC:TRAC1:TIME:STEP:RTIM:DATA 4.7E-11 :CALC:TRAC1:TIME:STEP:RTIM:DATA? Return: 5.24995058823529e-11

4.1.61 Stimulus Rise Time Type (:CALCulate:TRACe{Tr}:TIME:STEP:RTIME:THReshold)

Command Format	:CALCulate:TRACe{Tr}:TIME:STEP:RTIME:THReshold {T1_9 T2_8} :CALCulate:TRACe{Tr}:TIME:STEP:RTIME:THReshold?
Instruction	This command sets rise time threshold for the transform function.
Parameter Type	Enumeration
Parameter Range	T1_9 T2_8
Return	Enumeration
Default	T1_9
Menu	TDR/TDT > Parameter > Rise Time
Example	:CALC:TRAC1:TIME:STEP:RTIM:THR T2_8 :CALC:TRAC1:TIME:STEP:RTIM:THR? Return: T2_8

4.1.62 Time Domain Stimulus Type (:CALCulate:TRACe{Tr}:TIME:STIMulus)

Command Format	:CALCulate:TRACe{Tr}:TIME:STIMulus {LPSTep LPIMpulse} :CALCulate:TRACe{Tr}:TIME:STIMulus?
Instruction	This command sets stimulus type for the transform function.
Parameter Type	Enumeration
Parameter Range	LPSTep LPIMpulse
Return	Enumeration
Default	LPSTep
Menu	TDR/TDT > Parameter > Stimulus
Example	:CALC:TRAC1:TIME:STIM LPIMpulse :CALC:TRAC1:TIME:STIM? Return: LPIM

4.1.63 Rise Time Search Result (:CALCulate:TRACe{Tr}:TTIME:DATA)

Command Format	:CALCulate:TRACe{Tr}:TTIME:DATA?
Instruction	This command returns the rise time result value for marker search. You can get the data even if Rise Time Search is off.
Parameter Type	None
Parameter Range	None
Return	Float, unit: s (second)
Default	None
Menu	None
Example	:CALC:TRAC1:TTIM:DATA?

4.1.64 Rise Time Search Enable (:CALCulate:TRACe{Tr}:TTIME:STATE)

Command Format	:CALCulate:TRACe{Tr}:TTIME:STATE {ON OFF 1 0} :CALCulate:TRACe{Tr}:TTIME:STATE?
Instruction	This command displays the rise time marker.
Parameter Type	Boolean
Parameter Range	ON OFF 1 0
Return	Boolean
Default	OFF
Menu	TDR > Marker Search > Rise Time(10-90%)/Rise Time(20-80%)
Example	:CALC:TRAC1:TTIM:STAT ON :CALC:TRAC1:TTIM:STAT? Return: 1

4.1.65 Rise Time Search Type (:CALCulate:TRACe{Tr}:TTIME:STATE)

Command Format	:CALCulate:TRACe{Tr}:TTIME:THReshold {T1_9 T2_8} :CALCulate:TRACe{Tr}:TTIME:THReshold?
Instruction	This command sets the rise time threshold for the rise time in the marker search function.
Parameter Type	Enumeration
Parameter Range	T1_9 T2_8
Return	Enumeration
Default	T1_9
Menu	TDR > Marker Search > Rise Time(10-90%)/Rise Time(20-80%)
Example	:CALC:TRAC1:TTIM:THR T2_8 :CALC:TRAC1:TTIM:THR? Return: T2_8

4.2 Display Subsystem

4.2.1 Auto Scale All (:DISPlay:ATRaces:SCALE:AUTO)

Command Format	:DISPlay:ATRaces:SCALE:AUTO
Instruction	This command executes auto scale for all traces.
Parameter Type	None
Parameter Range	None
Return	None
Default	None
Menu	TDR > Auto Scale > All Trace
Example	:DISP:ATR:SCAL:AUTO

4.2.2 Horizontal Reference Position (:DISPlay:ATRaces:SCALE:RPOSITION)

Command Format	:DISPlay:ATRaces:SCALE:RPOSITION {LEFT CENTer} :DISPlay:ATRaces:SCALE:RPOSITION?
Instruction	This command sets x-axis reference position for the time domain measurement.
Parameter Type	Enumeration
Parameter Range	LEFT CENTer
Return	Enumeration
Default	LEFT
Menu	TDR/TDT > Horizontal > Reference Position Button
Example	:DISP:ATR:SCAL:RPOSITION CENT :DISP:ATR:SCAL:RPOSITION? Return: CENT

4.2.3 Waveform View Point (:DISPlay:ATRaces:VIEW)

Command Format	:DISPlay:ATRaces:VIEW {STIMulus RESPonse} :DISPlay:ATRaces:VIEW?
Instruction	This command selects the view point for waveform analysis either before or after DUT.
Parameter Type	Enumeration
Parameter Range	STIMulus RESPonse
Return	Enumeration
Default	RESPonse
Menu	Setup > Adv Waveform > Emphasis/Equalization > View
Example	:DISP:ATR:VIEW STIMulus :DISP:ATR:VIEW? Return: STIM

4.2.4 Eye Diagram Scale Auto (:DISPlay:EYE:Y:SCALe:AUTO)

Command Format	:DISPlay:EYE:Y:SCALe:AUTO
Instruction	This command executes Y axis auto scaling for eye diagram.
Parameter Type	None
Parameter Range	None
Return	None
Default	None
Menu	Eye/Mask > Scale/Mask > Auto Scale
Example	:DISP:EYE:Y:SCAL:AUTO

4.2.5 Eye Diagram Scale Manual (:DISPlay:EYE:Y:SCALe:MANual)

Command Format	:DISPlay:EYE:Y:SCALe:MANual
Instruction	This command changes the eye diagram scaling to manual mode. This command should be executed before the :DISPlay:EYE:Y:SCALe:PDIVision or :DISPlay:EYE:Y:SCALe:RLEVel commands are sent.
Parameter Type	None
Parameter Range	None
Return	None
Default	None
Menu	Eye/Mask > Scale/Mask > Manual
Example	:DISP:EYE:Y:SCAL:MAN

4.2.6 Eye Diagram Scale (:DISPlay:EYE:Y:SCALe:PDIVision)

Command Format	:DISPlay:EYE:Y:SCALe:PDIVision <numeric> :DISPlay:EYE:Y:SCALe:PDIVision?
Instruction	This command sets value of y-axis scale per division for eye diagram. The scale mode should be set at manual by the :DISPlay:EYE:Y:SCALe:MANual before this command is executed.
Parameter Type	Float, unit: V (Voltage)
Parameter Range	None
Return	Float, unit: V (Voltage)
Default	133mV
Menu	Eye/Mask > Scale/Mask > Scale/Div
Example	:DISP:EYE:Y:SCAL:PDIV 300E-03 :DISP:EYE:Y:SCAL:PDIV? Return: 0.3

4.2.7 Eye Diagram Offset (:DISPlay:EYE:Y:SCALE:RLEVel)

Command Format	:DISPlay:EYE:Y:SCALE:RLEVel <numeric> :DISPlay:EYE:Y:SCALE:RLEVel?
Instruction	This command sets value of eye diagram y-axis reference line. The scale mode should be set at manual by the :DISPlay:EYE:Y:SCALE:MANual before this command is executed.
Parameter Type	Float, unit: V (Voltage)
Parameter Range	None
Return	Float, unit: V (Voltage)
Default	0
Menu	Eye/Mask > Scale/Mask > Offset
Example	:DISP:EYE:Y:SCAL:RLEV 0.5 :DISP:EYE:Y:SCAL:RLEV? Return: 0.5

4.2.8 Trace Display Type (:DISPlay:TRACe{Tr}:DMEMory:TYPE)

Command Format	:DISPlay:TRACe{Tr}:DMEMory:TYPE {OFF DATA MEMory DMEMory} :DISPlay:TRACe{Tr}:DMEMory:TYPE?
Instruction	This command sets type of data/memory display.
Parameter Type	Enumeration
Parameter Range	OFF DATA MEMory DMEMory
Return	Enumeration
Default	DATA
Menu	TDR > Data/Mem > Off/Data/Memory/Data&Memory
Example	:DISP:TRAC1:DMEM:TYPE DMEMory :DISP:TRAC1:DMEM:TYPE? Return: DMEM

4.2.9 Trace X Axis Auto Scale (:DISPlay:TRACe{Tr}:X:SCALE:AUTO)

Command Format	:DISPlay:TRACe{Tr}:X:SCALE:AUTO
Instruction	This command executes x-axis auto scaling.
Parameter Type	None
Parameter Range	None
Return	None
Default	None
Menu	TDR > Auto Scale > X
Example	:DISP:TRAC1:X:SCAL:AUTO

4.2.10 Trace X Axis Scale (:DISPlay:TRACe{Tr}:X:SCALe:PDIVision)

Command Format	:DISPlay:TRACe{Tr}:X:SCALe:PDIVision <numeric> :DISPlay:TRACe{Tr}:X:SCALe:PDIVision?
Instruction	This command sets value of x-axis scale per division.
Parameter Type	Float, unit: s (second)
Parameter Range	None
Return	Float, unit: s (second)
Default	None
Menu	TDR/TDT > Horizontal > Scale
Example	:DISP:TRAC1:X:SCAL:PDIV 1E-9 :DISP:TRAC1:X:SCAL:PDIV? Return: 1e-09

4.2.11 Trace X Axis Offset (:DISPlay:TRACe{Tr}:X:SCALe:RLEVel)

Command Format	:DISPlay:TRACe{Tr}:X:SCALe:RLEVel <numeric> :DISPlay:TRACe{Tr}:X:SCALe:RLEVel?
Instruction	This command sets value of x-axis reference line.
Parameter Type	Float, unit: s (second)
Parameter Range	None
Return	Float, unit: s (second)
Default	None
Menu	TDR/TDT > Horizontal > Offset
Example	:DISP:TRAC1:X:SCAL:RLEV 2E-8 :DISP:TRAC1:X:SCAL:RLEV? Return: 2e-08

4.2.12 Trace Y Axis Auto Scale (:DISPlay:TRACe{Tr}:Y:SCALe:AUTO)

Command Format	:DISPlay:TRACe{Tr}:Y:SCALe:AUTO
Instruction	This command executes y-axis auto scaling.
Parameter Type	None
Parameter Range	None
Return	None
Default	None
Menu	TDR > Auto Scale > Y
Example	:DISP:TRAC1:Y:SCAL:AUTO

4.2.13 Trace Y Axis Scale (:DISPlay:TRACe{Tr}:Y:SCALe:PDIVision)

Command Format	:DISPlay:TRACe{Tr}:Y:SCALe:PDIVision <numeric> :DISPlay:TRACe{Tr}:Y:SCALe:PDIVision?
Instruction	This command sets value of y-axis scale per division.
Parameter Type	Float
Parameter Range	None
Return	Float
Default	None
Menu	TDR/TDT > Vertical > Scale
Example	:DISP:TRAC1:Y:SCAL:PDIV 10 :DISP:TRAC1:Y:SCAL:PDIV? Return: 10

4.2.14 Trace Y Axis Offset (:DISPlay:TRACe{Tr}:Y:SCALe:RLEVel)

Command Format	:DISPlay:TRACe{Tr}:Y:SCALe:RLEVel <numeric> :DISPlay:TRACe{Tr}:Y:SCALe:RLEVel?
Instruction	This command sets value of y-axis reference line.
Parameter Type	Float
Parameter Range	None
Return	Float
Default	None
Menu	TDR/TDT > Vertical > Offset
Example	:DISP:TRAC1:Y:SCAL:RLEV 20 :DISP:TRAC1:Y:SCAL:RLEV? Return: 20

4.3 Memory Subsystem

4.3.1 Load User Bit Pattern (:MMEMory:LOAD:EYE:BPATtern)

Command Format	:MMEMory:LOAD:EYE:BPATtern <string>
Instruction	This command loads the specified user bit pattern file. The extension of file should be .txt.
Parameter Type	String
Parameter Range	File name of user bit pattern (.txt)
Return	None
Default	None
Menu	Eye/Mask > Stimulus > User Pattern > Load
Example	:MMEM:LOAD:EYE:BPAT "local/userbit.txt"

4.3.2 Load User Mask Pattern (:MMEMory:LOAD:EYE:MASK)

Command Format	:MMEMory:LOAD:EYE:MASK <string>
Instruction	This command loads eye-mask file. The extension of file should be .msk. The MASK pattern editing is not available through the command.
Parameter Type	String
Parameter Range	File name of eye mask (.msk)
Return	None
Default	None
Menu	Eye/Mask > Scale/Mask > Mask Pattern > Use User-defined mask files > Load
Example	:MMEM:LOAD:EYE:MASK "local/usermask.msk"

4.4 Sense Subsystem

4.4.1 Dielectric Constant (:SENSe:CORRection:DCONstant)

Command Format	:SENSe:CORRection:DCONstant <numeric> :SENSe:CORRection:DCONstant?
Instruction	This command sets dielectric constant value.
Parameter Type	Float
Parameter Range	None
Return	Float
Default	1
Menu	Setup > More Functions > Dielectric Const.
Example	:SENS:CORR:DCON 2 :SENS:CORR:DCON? Return: 2

4.4.2 System Impedance (:SENSe:CORRection:RIMPedance)

Command Format	:SENSe:CORRection:RIMPedance <numeric> :SENSe:CORRection:RIMPedance?
Instruction	This command sets reference impedance value.
Parameter Type	Float
Parameter Range	None
Return	Float
Default	50
Menu	Setup > More Functions > Ref. Z
Example	:SENS:CORR:RIMP 75 :SENS:CORR:RIMP? Return: 75

4.4.3 Deskew Standard Type (:SENSe:CORRection:EXTension:AUTO:STANdard)

Command Format	:SENSe:CORRection:EXTension:AUTO:STANdard {OPEN SHORT} :SENSe:CORRection:EXTension:AUTO:STANdard?
Instruction	This command sets the standard for auto port extension.
Parameter Type	Enumeration
Parameter Range	OPEN SHORT
Return	Enumeration

Default	OPEN
Menu	Setup > Basic > Deskew > Options > Standard Type Setup > Basic > Deskew&Loss > Options > Standard Type
Example	:SENS:CORR:EXT:AUTO:STAN SHOR :SENS:CORR:EXT:AUTO:STAN? Return: SHOR

4.4.4 Execute Deskew (:SENSe:CORRection:EXTension:AUTO:IMMediate)

Command Format	:SENSe:CORRection:EXTension:AUTO:IMMediate
Instruction	This command executes deskew (auto port extension).
Parameter Type	None
Parameter Range	None
Return	None
Default	None
Menu	Setup > Basic > Deskew > Deskew
Example	:SENS:CORR:EXT:AUTO:STAN SHOR :SENS:CORR:EXT:AUTO:IMM

4.4.5 Deskew & Loss Open (:SENSe:CORRection:COLLection:DLComp:OPEN)

Command Format	:SENSe:CORRection:COLLection:DLComp:OPEN
Instruction	This command executes an open measurement, as a part of Loss Compensation sequence.
Parameter Type	None
Parameter Range	None
Return	None
Default	None
Menu	Setup > Basic > Deskew & Loss > Measure
Example	:SENS:CORR:COLL:DLC:OPEN :SENS:CORR:COLL:DLC:SAVE

4.4.6 Deskew & Loss Thru (:SENSe:CORRection:COLLection:DLComp:THRU)

Command Format	:SENSe:CORRection:COLLection:DLComp:THRU
Instruction	This command executes a thru measurement, as a part of Loss Compensation sequence.
Parameter Type	None
Parameter Range	None
Return	None

Default	None
Menu	Setup > Basic > Deskew & Loss > Measure
Example	:SENS:CORR:COLL:DLC:THRU

4.4.7 Deskew & Loss Load (:SENSe:CORRection:COLLection:DLComp:LOAD)

Command Format	:SENSe:CORRection:COLLection:DLComp:LOAD
Instruction	This command executes a load measurement, as a part of Loss Compensation sequence.
Parameter Type	None
Parameter Range	None
Return	None
Default	None
Menu	Setup > Basic > Deskew & Loss > Load x
Example	:SENS:CORR:COLL:DLC:LOAD

4.4.8 Deskew & Loss Save (:SENSe:CORRection:COLLection:DLComp:SAVE)

Command Format	:SENSe:CORRection:COLLection:DLComp:SAVE
Instruction	This command saves the result of Loss Compensation sequence.
Parameter Type	None
Parameter Range	None
Return	None
Default	None
Menu	Setup > Basic > Deskew & Loss > Apply
Example	:SENS:CORR:COLL:DLC:OPEN :SENS:CORR:COLL:DLC:THRU :SENS:CORR:COLL:DLC:LOAD :SENS:CORR:COLL:DLC:SAVE

4.4.9 Measure DUT length (:SENSe:DLENgth:AUTO:IMMediate)

Command Format	:SENSe:DLENgth:AUTO:IMMediate
Instruction	This command executes auto DUT length setting.
Parameter Type	None
Parameter Range	None
Return	None
Default	None

Menu	Setup > Basic > DUT Length > Auto > Measure
Example	:SENS:DLEN:AUTO:IMM

4.4.10 DUT length (:SENSe:DLENgth:DATA)

Command Format	:SENSe:DLENgth:DATA <numeric> :SENSe:DLENgth:DATA?
Instruction	This command sets DUT length value.
Parameter Type	Float, unit: s (second)
Parameter Range	None
Return	Float, unit: s (second)
Default	None
Menu	Setup > Basic > DUT Length
Example	:SENS:DLEN:DATA 6.26e-9 :SENS:DLEN:DATA? Return: 6.26e-09

4.4.11 Avoid Spurious (:SENSe:SPURious:AVOid:IMMediate)

Command Format	:SENSe:SPURious:AVOid:IMMediate
Instruction	This command executes avoid spurious.
Parameter Type	None
Parameter Range	None
Return	None
Default	None
Menu	Setup > Hot TDR > Avoid Spurious
Example	:SENS:SPUR:AVO:IMM

4.4.12 Avoid Spurious State (:SENSe:SPURious:AVOid:STATe?)

Command Format	:SENSe:SPURious:AVOid:STATe?
Instruction	This command queries the avoid spurious state. This command is ON when :SENS:SPURious:AVOid:IMMediate command succeeds. This command is OFF when :SENS:SPURious:AVOid:IMMediate command fails to find spurious.
Parameter Type	None
Parameter Range	None
Return	Boolean
Default	OFF
Menu	Setup > Hot TDR > Avoid Spurious
Example	:SENS:SPUR:AVO:STAT?

4.4.13 Spurious Data Rate (:SENSe:SPURious:INPut:DRATe)

Command Format	:SENSe:SPURious:INPut:DRATe <numeric> :SENSe:SPURious:INPut:DRATe?
Instruction	This command sets the value of input bit rate for avoid spurious.
Parameter Type	Float, unit: b/s
Parameter Range	20Mb/s~ 2.4Gb/s
Return	Float, unit: b/s
Default	1Gb/s
Menu	Setup > Hot TDR > Data Rate
Example	:SENS:SPUR:INP:DRAT 2e9 :SENS:SPUR:INP:DRAT? Return: 2000000000

4.4.14 Hot TDR State (:SENSe:SPURious:STATe?)

Command Format	:SENSe:SPURious:STATe?
Instruction	This command queries the Hot TDR mode status. To turn ON Hot TDR mode, use :SENSe:SPURious:AVOid:IMMEDIATE; to turn OFF Hot TDR mode, use :SYSTem:PRESet.
Parameter Type	None
Parameter Range	None
Return	Boolean
Default	OFF
Menu	None
Example	:SENS:SPUR:STAT?

4.5 Trigger Subsystem

4.5.1 Average Enable (:TRIGger:AVERage)

Command Format	:TRIGger:AVERage {ON OFF 1 0} :TRIGger:AVERage?
Instruction	This command sets averaging trigger on/off. When averaging trigger is on, one trigger makes one averaging measurement. For example, if the averaging factor is set at 16, one trigger makes a measurement for 16 times.
Parameter Type	Boolean
Parameter Range	ON OFF 1 0
Return	Boolean
Default	OFF
Menu	Setup > Average > Averaging
Example	:TRIG:AVER ON :TRIG:AVER? Return: 1

4.5.2 Trigger Mode(:TRIGger:AVERage)

Command Format	:TRIGger:MODE {HOLD SINGle RUN} :TRIGger:MODE?
Instruction	This command sets/gets trigger mode.
Parameter Type	Enumeration
Parameter Range	HOLD SINGle RUN
Return	Enumeration
Default	RUN
Menu	Setup > Run / Stop/Single
Example	:TRIG:MODE HOLD :TRIG:MODE? Return: HOLD

4.6 System Subsystem

4.6.1 TDR Option Preset (:SYSTem:TDR:PRESet)

Command Format	:SYSTem:TDR:PRESet
Instruction	This command sets the TDR option to the default state. Calibration data will be lost.
Parameter Type	None
Parameter Range	None
Return	None
Default	None
Menu	Setup > Basic > Preset
Example	:SYST:TDR:PRES

5. Programming Examples

This chapter gives some examples for the programmer. In these examples you can see how to use the VISA or sockets, in combination with the commands have been described above to control the vna. By following these examples, you can develop many more applications.

5.1 Examples of Using VISA

5.1.1 Example of VC++

Environment: Win7 32bit system, Visual Studio

The functions of this example: use the NI-VISA, to control the device with USBTMC or TC P/IP access to do a write and read.

Follow the steps to finish the example:

1. Open Visual Studio, create a new VC++ win32 console project.
2. Set the project environment to use the NI-VISA lib, there are two ways to use NI-VISA, static or automatic:

(1) Static: find files: visa.h, visatype.h, visa32.lib in NI-VISA install path. Copy them to your project, and add them into project. In the projectname.cpp file, add the follow two lines:

```
#include "visa.h"
```

```
#pragma comment(lib,"visa32.lib")
```

(2) Automatic:

Set the .h file include directory, the NI-VISA install path, in our computer we set the path is: C:\Program Files\IVI Foundation\VISAWinNT\include. Set this path to project---properties--- c/ c+----General---Additional Include Directories. See the picture.

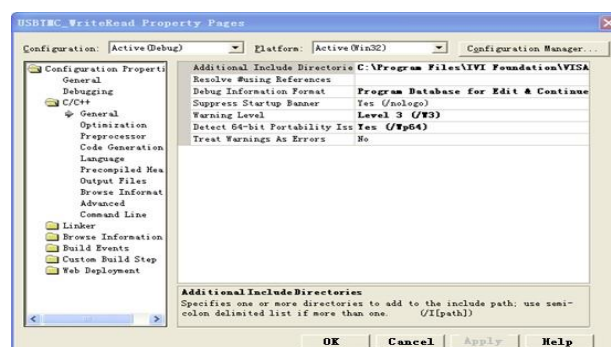

Set lib path set lib file:

Set lib path: the NI-VISA install path, in our computer we set the path is: C:\Program Files\IVI Foundation\VISAWinNT\lib\msc. Set this path to project---properties---Linker---General---Additional Library Directories: as seen in the pictures below.

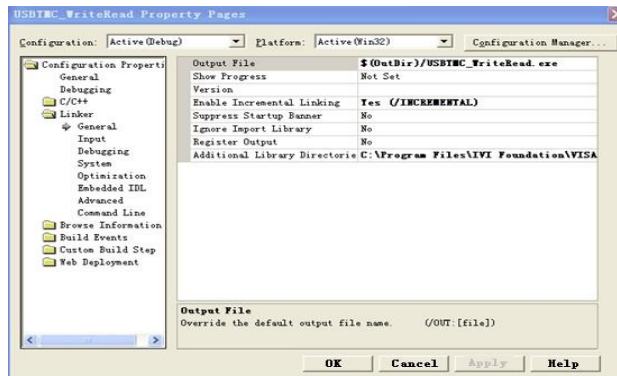

Set lib file:project---properties---Linker---Command Line---Additional Options:
visa32.lib

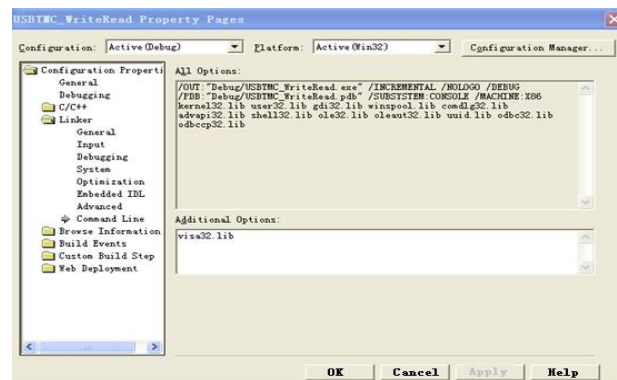

Include visa.h file: In the projectname.cpp file:

```
#include <visa.h>
```

3. Add codes:

(1) USBTMC access code.

Write a function Usbtmc_test:

```
int Usbtmc_test()
{
    /* This code demonstrates sending synchronous read & write commands */
    /* to an USB Test & Measurement Class (USBTMC) instrument using */
    /* NI-VISA */
    /* The example writes the "*IDN?\n" string to all the USBTMC */
    /* devices connected to the system and attempts to read back */
    /* results using the write and read functions. */
    /* The general flow of the code is */
    /* Open Resource Manager */
    /* Open VISA Session to an Instrument */
    /* Write the Identification Query Using viPrintf */
    /* Try to Read a Response With viScanf */
    /* Close the VISA Session */
    /*******/
    ViSession defaultRM;
    ViSession instr;
    ViUInt32 numInstrs;
    ViFindList findList;
    ViUInt32 retCount;
    ViUInt32 writeCount;
    ViStatus status;
    Char instrResourceString[VI_FIND_BUFLLEN];
    Unsigned char buffer[100];
    char stringinput[512];
    int i;
    /** First we must call viOpenDefaultRM to get the manager
    * handle. We will store this handle in defaultRM.*/
    status=viOpenDefaultRM (&defaultRM);
    if (status<VI_SUCCESS)
```

```

{
printf ("Could not open a session to the VISA Resource Manager!\n");
return status;
}

/* Find all the USB TMC VISA resources in our system and store the number of resources in the system in
numInstrs.*/
status = viFindRsrc (defaultRM, "USB?*INSTR", &findList, &numInstrs, instrResourceString);
if (status<VI_SUCCESS)
{
printf ("An error occurred while finding resources.\nPress 'Enter' to continue.");
fflush(stdin);
getchar();
viClose (defaultRM);
returnstatus;
}
/** Now we will open VISA sessions to all USB TMC instruments.
* We must use the handle from viOpenDefaultRM and we must
* also use a string that indicates which instrument to open. This
* is called the instrument descriptor. The format for this string
* can be found in the function panel by right clicking on the
* descriptor parameter. After opening a session to the
* device, we will get a handle to the instrument which we
* will use in later VISA functions. The AccessMode and Timeout
* parameters in this function are reserved for future
* functionality. These two parameters are given the value VI_NULL.*/
for (i=0; i<int(numInstrs); i++)
{
if (i> 0)
{
viFindNext (findList, instrResourceString);
}
status = viOpen (defaultRM, instrResourceString, VI_NULL, VI_NULL, &instr);
if (status<VI_SUCCESS)
{
printf ("Cannot open a session to the device %d.\n", i+1);
continue;
}
/* * At this point we now have a session open to the USB TMC instrument.
* We will now use the viPrintf function to send the device the string "*IDN?\n",
* asking for the device's identification. */
char * cmmand ="*IDN?\n";
status = viPrintf (instr, cmmand);
if (status<VI_SUCCESS)
{
printf ("Error writing to the device %d.\n", i+1);
status = viClose (instr);
continue;
}
/** Now we will attempt to read back a response from the device to
* the identification query that was sent. We will use the viScanf
* function to acquire the data.
* After the data has been read the response is displayed.*/
status = viScanf(instr, "%t", buffer);
if (status<VI_SUCCESS)
{
printf ("Error reading a response from the device %d.\n", i+1);
}
else
{
printf ("\nDevice %d:%s\n", i+1, buffer);
}
status = viClose (instr);
}
/** Now we will close the session to the instrument using
* viClose. This operation frees all system resources. */
status = viClose (defaultRM);
printf("Press 'Enter' to exit.");
fflush(stdin);
getchar();

```



```

return 0;
}

int _tmain(int argc, _TCHAR* argv[])
{
    Usbtmc_test();
    return 0;
}

```

Run result:

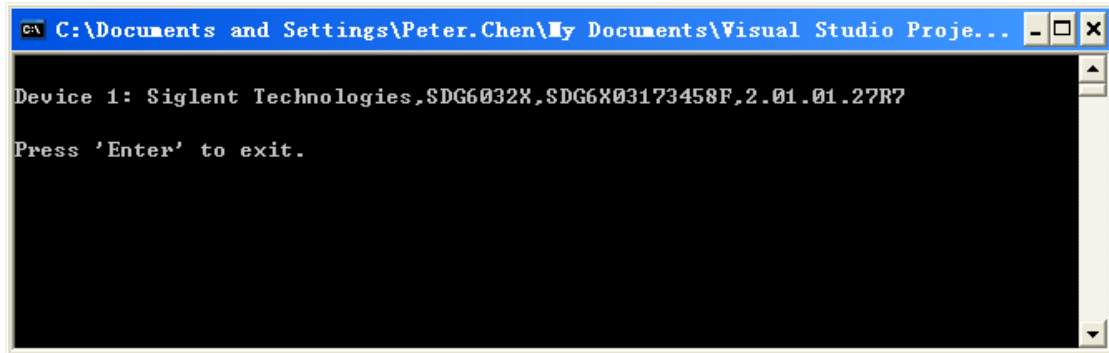

(2) TCP/IP access code.

Write a function TCP_IP_Test:

```

int TCP_IP_Test(char *pIP)
{
    char outputBuffer[VI_FIND_BUFLLEN];
    ViSessiondefaultRM, instr;
    ViStatusstatus;

    /* First we will need to open the default resource manager. */
    status = viOpenDefaultRM (&defaultRM);
    if (status<VI_SUCCESS)
    {
        printf("Could not open a session to the VISA Resource Manager!\n");
    }
    /* Now we will open a session via TCP/IP device */
    char head[256] = "TCPIP0::";
    char tail[] = "::INSTR";

    strcat(head,pIP);
    strcat(head,tail);
    status = viOpen (defaultRM, head, VI_LOAD_CONFIG, VI_NULL, &instr);
    if (status<VI_SUCCESS)
    {
        printf ("Anerror occurred opening the session\n");
        viClose(defaultRM);
    }
    status = viPrintf(instr, "*idn?\n");
    status = viScanf(instr, "%t", outputBuffer);
    if (status<VI_SUCCESS)
    {
        printf("viRead failed with error code:%x \n",status);
        viClose(defaultRM);
    }
    else
    {
        printf ("\nMesseage read from device:%*s\n", 0,outputBuffer);
    }
    status = viClose (instr);
    status = viClose (defaultRM);
    printf("Press 'Enter' to exit.");
    fflush(stdin);
    getchar();
    return 0;
}

```

```

int _tmain(int argc, _TCHAR* argv[])
{
printf("Please input IP address:");
char ip[256];
fflush(stdin);
gets(ip);
TCP_IP_Test(ip);
return 0;
}

```

Run result:

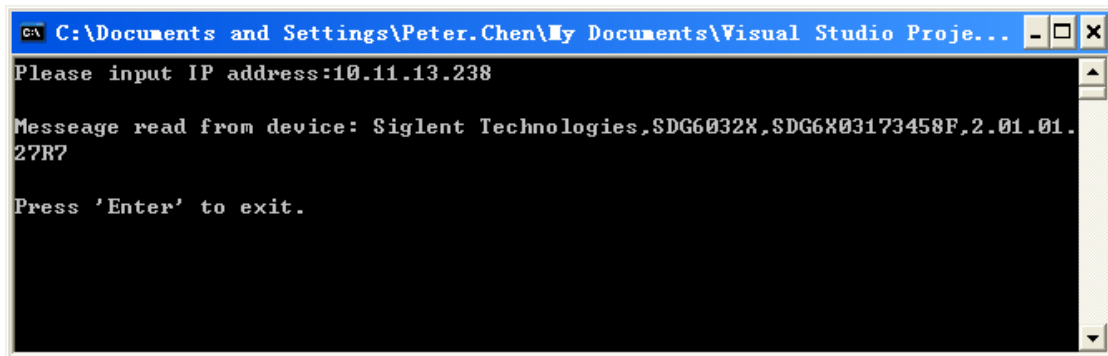

5.1.2 Example of VB

Environment: Win7 32bit system, Microsoft Visual Basic 6.0

The function of this example: Use the NI-VISA, to control the device with USBTMC and TCP/IP access to do a write and read.

Follow the steps to complete the example:

1. Open Visual Basic, build a standard application program project (Standard EXE)
2. Set the project environment to use the NI-VISA lib, Click the Existing tab of Project>>Add Existing Item. Search for the visa32.bas file in the include folder under the NI-VISA installation path and add the file.



This allows the VISA functions and VISA data types to be used in a program.

3. Add codes:

(1) USBTMC access code.

(2) Write a function Usbtmc_test:

```
Private Function Usbtmc_test() As Long
```

```
'This code demonstrates sending synchronous read & write commands
```

```
'' to an USB Test & Measurement Class (USBTMC) instrument using
```

```
' NI-VISA
```

```
' The example writes the "*IDN?\n" string to all the USBTMC
```

```

' devices connected to the system and attempts to read back
' results using the write and read functions.
' The general flow of the code is
' Open Resource Manager
' Open VISA Session to an Instrument
' Write the Identification Query Using viWrite
' Try to Read a Response With viRead
' Close the VISA Session

Const MAX_CNT = 200
Dim defaultRM As Long
Dim instrsesn As Long
Dim numInstrs As Long
Dim findList As Long
Dim retCount As Long

Dim status As Long
Dim instrResourceString As String * VI_FIND_BUFLen
Dim Buffer As String * MAX_CNT
Dim i As Integer
' First we must call viOpenDefaultRM to get the manager
' handle. We will store this handle in defaultRM.
status = viOpenDefaultRM(defaultRM)
If (status < VI_SUCCESS) Then
    resultTxt.Text = "Could not open a session to the VISA Resource Manager!"
    Usbtmc_test = status
    Exit Function
End If

' Find all the USB TMC VISA resources in our system and store the
' number of resources in the system in numInstrs.
status = viFindRsrc(defaultRM, "USB?*INSTR", findList, numInstrs, instrResourceString)
If (status < VI_SUCCESS) Then
    resultTxt.Text = "An error occurred while finding resources."
    viClose (defaultRM)
    Usbtmc_test = status
    Exit Function
End If

' Now we will open VISA sessions to all USB TMC instruments.
' We must use the handle from viOpenDefaultRM and we must
' also use a string that indicates which instrument to open. This
' is called the instrument descriptor. The format for this string
' can be found in the function panel by right clicking on the
' descriptor parameter. After opening a session to the
' device, we will get a handle to the instrument which we
' will use in later VISA functions. The AccessMode and Timeout
' parameters in this function are reserved for future
' functionality. These two parameters are given the value VI_NULL.
For i = 0 To numInstrs
    If (i > 0) Then
        status = viFindNext(findList, instrResourceString)
        End If
        status = viOpen(defaultRM, instrResourceString, VI_NULL, VI_NULL, instrsesn)
        If (status < VI_SUCCESS) Then
            resultTxt.Text = "Cannot open a session to the device " + CStr(i + 1)
            GoTo NextFind
        End If

' At this point we now have a session open to the USB TMC instrument.
' We will now use the viWrite function to send the device the string "*IDN?",
' asking for the device's identification.
        status = viWrite(instrsesn, "*IDN?", 5, retCount)
        If (status < VI_SUCCESS) Then
            resultTxt.Text = "Error writing to the device."
            status = viClose(instrsesn)
            GoTo NextFind
        End If
    End If
End For

```

```

' Now we will attempt to read back a response from the device to
' the identification query that was sent. We will use the viRead
' function to acquire the data.
' After the data has been read the response is displayed.

    status = viRead(instrsesn, Buffer, MAX_CNT, retCount)
    If (status < VI_SUCCESS) Then
        resultTxt.Text = "Error reading a response from the device." + CStr(i + 1)
    Else
        resultTxt.Text = "Read from device:" + CStr(i + 1) + " " + Buffer
    End If
    status = viClose(instrsesn)
Next i

' Now we will close the session to the instrument using
' viClose. This operation frees all system resources.
status = viClose(defaultRM)
Usbtmc_test = 0
End Function

(3) TCP/IP access code.
Write a function TCP_IP_Test:
Private Function TCP_IP_Test(ByVal ip As String) As Long
    Dim outputBuffer As String * VI_FIND_BUFLen
    Dim defaultRM As Long
    Dim instrsesn As Long
    Dim status As Long
    Dim count As Long

' First we will need to open the default resource manager.
status = viOpenDefaultRM (defaultRM)
If (status < VI_SUCCESS) Then
    resultTxt.Text = "Could not open a session to the VISA Resource Manager!"
    TCP_IP_Test = status
    Exit Function
End If

' Now we will open a session via TCP/IP device
status = viOpen(defaultRM, "TCPIP0::" + ip + "::INSTR", VI_LOAD_CONFIG, VI_NULL, instrsesn)
If (status < VI_SUCCESS) Then
    resultTxt.Text = "An error occurred opening the session"
    viClose (defaultRM)
    TCP_IP_Test = status
    Exit Function
End If

    status = viWrite(instrsesn, "**IDN?", 5, count)
    If (status < VI_SUCCESS) Then
        resultTxt.Text = "Error writing to the device."
    End If
    status = viRead(instrsesn, outputBuffer, VI_FIND_BUFLen, count)
    If (status < VI_SUCCESS) Then
        resultTxt.Text = "Error reading a response from the device." + CStr(i + 1)
    Else
        resultTxt.Text = "read from device:" + outputBuffer
    End If
    status = viClose(instrsesn)
    status = viClose(defaultRM)
    TCP_IP_Test = 0
End Function

(4) Button control code:

    Private Sub exitBtn_Click()
        End
    End Sub
    Private Sub tcpipBtn_Click()

        Dim stat As Long

```

```

stat = TCP_IP_Test(ipTxt.Text)
If (stat < VI_SUCCESS) Then

    resultTxt.Text = Hex(stat)
End If
End Sub
Private Sub usbBtn_Click()
    Dim stat As Long
    stat = Usbtmc_test
    If (stat < VI_SUCCESS) Then
        resultTxt.Text = Hex(stat)
    End If
End Sub

```

Run result:

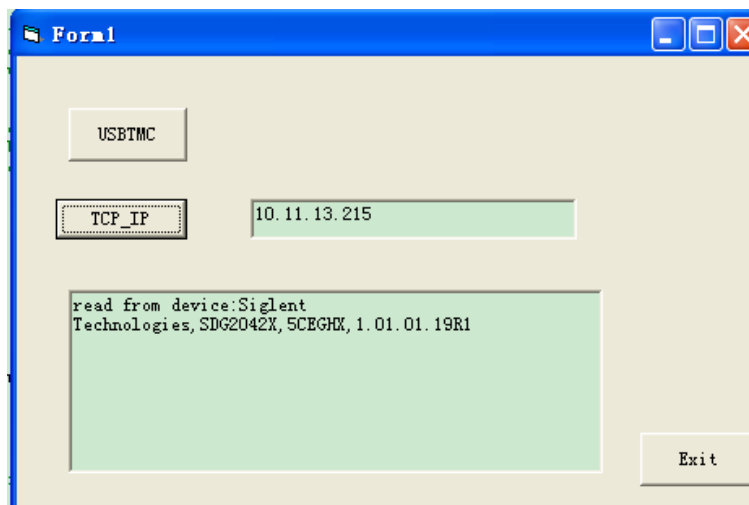

5.1.3 Example of MATLAB

Environment: Win7 32bit system, MATLAB R2013a

The function of this example: Use the NI-VISA, to control the device with USBTMC or TCP/IP access to do a write and read.

Follow the steps to complete the example:

1. Open MATLAB, modify the **current directory**. In this demo, the current directory is modified to D:\USBTMC_TCPIP_Demo.
2. Click **File>>New>>Script** in the Matlab interface to create an empty M file.
3. Add codes:
 - (1)USBTMC access code
 - Write a function Usbtmc_test.
 - `function USBTMC_test()`
 - `% This code demonstrates sending synchronous read & write commands`
 - `% to an USB Test & Measurement Class (USBTMC) instrument using`
 - `% NI-VISA`
 -
 - `%Create a VISA-USB object connected to a USB instrument`
 - `vu = visa('ni','USB0::0xF4ED::0xEE3A::sdg2000x::INSTR');`
 -
 - `%Open the VISA object created`
 - `fopen(vu);`
 -
 - `%Send the string "*IDN?" asking for the device's identification.`

```
fprintf(vu, '*IDN?');

%Request the data
outputbuffer = fscanf(vu);
disp(outputbuffer);

%Close the VISA object
fclose(vu);
delete(vu);
clear vu;

end
```

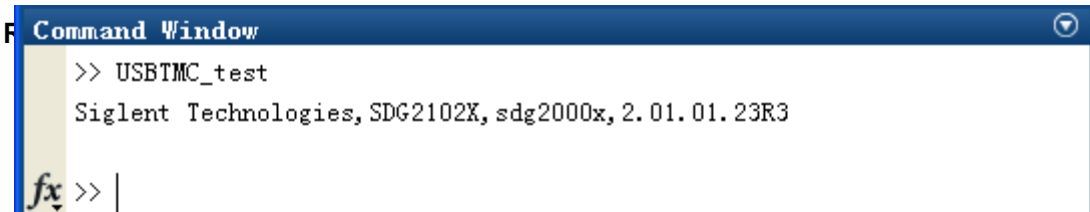

```
Command Window
>> USBTMC_test
Siglent Technologies, SDG2102X, sdg2000x, 2.01.01.23R3
fx >> |
```

(2)TCP/IP access code.

Write a function TCP_IP_Test:

```
function TCP_IP_test()
% This code demonstrates sending synchronous read & write commands
% to an TCP/IP instrument using NI-VISA

%Create a VISA-TCPIP object connected to an instrument
%configured with IP address.
vt = visa('ni', ['TCPIP0::', '10.11.13.32', '::INSTR']);

%Open the VISA object created
fopen(vt);

%Send the string "*IDN?", asking for the device's identification.
fprintf(vt, '*IDN?');

%Request the data
outputbuffer = fscanf(vt);
disp(outputbuffer);

%Close the VISA object
fclose(vt);
delete(vt);
clear vt;

end
```

Run result:

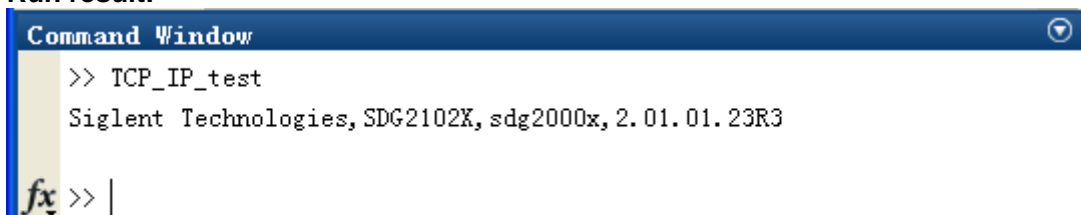

```
Command Window
>> TCP_IP_test
Siglent Technologies, SDG2102X, sdg2000x, 2.01.01.23R3
fx >> |
```

5.1.4 Example of LabVIEW

Environment: Win7 32bit system, LabVIEW 2011

The functions of this example: use the NI-VISA, to control the device with USBTMC and TCP/IP access to do a write and read.

Follow the steps to complete the example:

1. Open LabVIEW, create a VI file.
2. Add controls. Right-click in the **Front Panel** interface, select and add **VISA resource name**, error in, error out and some indicators from the Controls column.
3. Open the **Block Diagram** interface. Right-click on the **VISA resource name** and you can select and add the following functions from VISA Palette from the pop-up menu: **VISA Write**, **VISA Read**, **VISA Open** and **VISA Close**.
4. Connect them as shown in the figure below

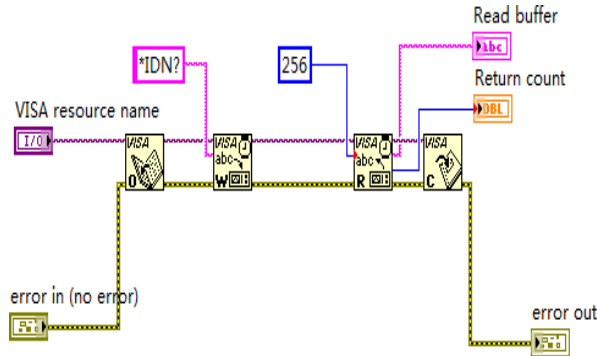

5. Select the device resource from the VISA Resource Name list box and run the program.

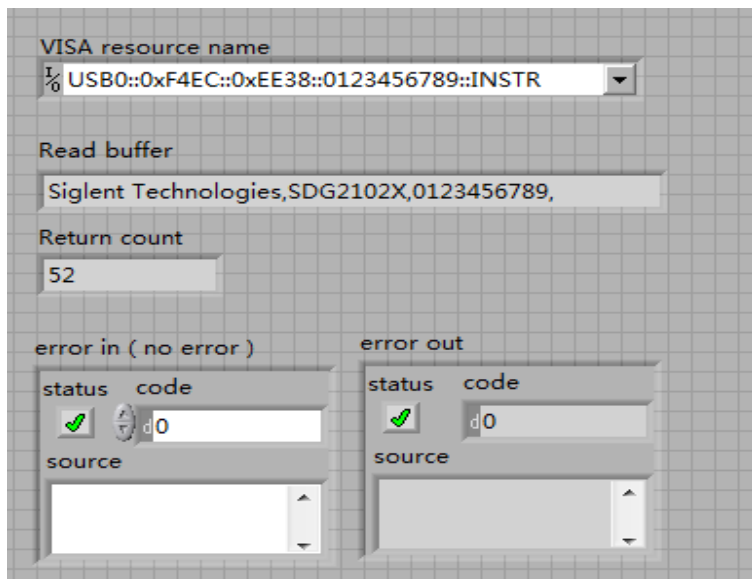

In this example, the VI opens a VISA session to a USBTMC device, writes a command to the device, and reads back the response. In this example, the specific command being sent is the device ID query. Check with your device manufacturer for the device command set. After all communication is complete, the VI closes the VISA session.

6. Communicating with the device via TCP/IP is similar to USBTMC. But you need to change VISA Write and VISA Read Function to Synchronous I/O. The LabVIEW default is asynchronous I/O. Right-click the node and select Synchronous I/O Mod>>Synchronous from the shortcut menu to write or read data synchronously.
7. Connect them as shown in the figure below

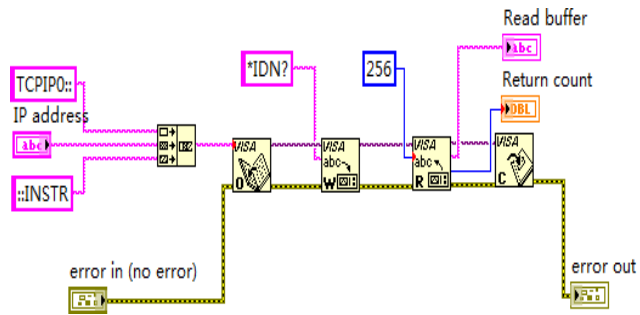

8. Input the IP address and run the program.

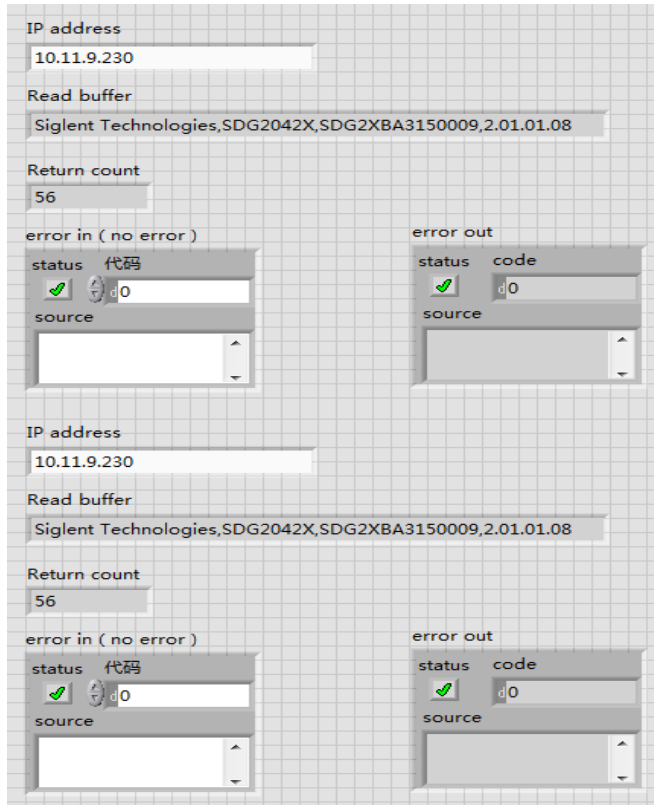

5.2 Examples of Using Sockets/Telnet

5.2.1 Example of Python

Python is an interpreted programming language that lets you work quickly and is very portable. Python has a low-level networking module that provides access to the socket interface. Python scripts can be written for sockets to do a variety of test and measurements tasks.

Environment: Win7 32bit system, Python v2.7.5

The functions of this example: Open a socket, sends a query, and closes the socket. It does this loop 10 times.

Below is the code of the script:

```
#!/usr/bin/env python
#-*- coding:utf-8 -*-
#-----
# The short script is a example that open a socket, sends a query,
# print the return message and closes the socket.
#-----
import socket # for sockets
import sys # for exit
import time # for sleep
#-----
remote_ip = "10.11.13.32" # should match the instrument's IP address
port = 5024 # the port number of the instrument service
count = 0

def SocketConnect():
    try:
        #create an AF_INET, STREAM socket (TCP)
        s = socket.socket(socket.AF_INET, socket.SOCK_STREAM)
    except socket.error:
        print ('Failed to create socket.')
        sys.exit();
    try:
        #Connect to remote server
        s.connect((remote_ip , port))
        info = s.recv(4096)
        print (info)
    except socket.error:
        print ('failed to connect to ip ' + remote_ip)
    return s

def SocketQuery(Sock, cmd):
    try :
        #Send cmd string
        Sock.sendall(cmd)
        time.sleep(1)
    except socket.error:
        #Send failed
        print ('Send failed')
        sys.exit()
    reply = Sock.recv(4096)
    return reply

def SocketClose(Sock):
    #close the socket
    Sock.close()
    time.sleep(.300)

def main():
```

```

global remote_ip
global port
global count

# Body:send the SCPI commands *IDN? 10 times and print the return message
s = SocketConnect()
for i in range(10):
    qStr = SocketQuery(s, b'*IDN?')
    print (str(count) + "::" + str(qStr))
    count = count + 1
SocketClose(s)
input('Press "Enter" to exit')

if name == ' main ':
    proc = main()

```

Run result:

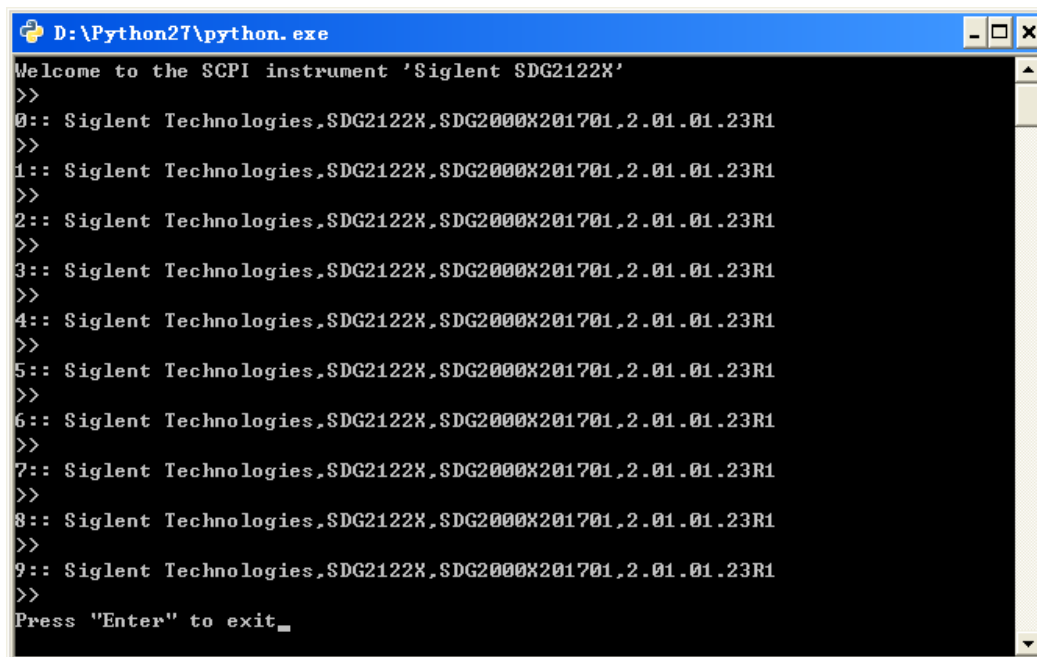

```

D:\Python27\python.exe
Welcome to the SCPI instrument 'Siglent SDG2122X'
>>
0:: Siglent Technologies,SDG2122X,SDG2000X201701,2.01.01.23R1
>>
1:: Siglent Technologies,SDG2122X,SDG2000X201701,2.01.01.23R1
>>
2:: Siglent Technologies,SDG2122X,SDG2000X201701,2.01.01.23R1
>>
3:: Siglent Technologies,SDG2122X,SDG2000X201701,2.01.01.23R1
>>
4:: Siglent Technologies,SDG2122X,SDG2000X201701,2.01.01.23R1
>>
5:: Siglent Technologies,SDG2122X,SDG2000X201701,2.01.01.23R1
>>
6:: Siglent Technologies,SDG2122X,SDG2000X201701,2.01.01.23R1
>>
7:: Siglent Technologies,SDG2122X,SDG2000X201701,2.01.01.23R1
>>
8:: Siglent Technologies,SDG2122X,SDG2000X201701,2.01.01.23R1
>>
9:: Siglent Technologies,SDG2122X,SDG2000X201701,2.01.01.23R1
>>
Press "Enter" to exit_

```

5.2.2 Example of Telnet

Telnet SCPI: Provides the ability to send single SCPI commands from a remote PC to the analyzer using LAN port number 5024.

How to send single SCPI commands using Telnet:

1. On the remote PC, click **Start**, then **Run**
2. Type: **telnet <ip address> 5024**
3. A Telnet window with a **>>** prompt should appear on the remote PC screen.

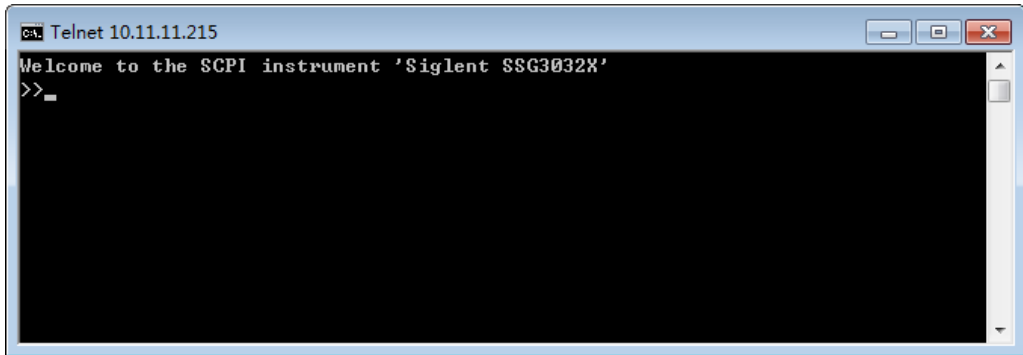

```
ca. Telnet 10.11.11.215
Welcome to the SCPI instrument 'Siglent SSG3032X'
>>_
```

4. From the SCPI prompt:
 - Type single SCPI commands. Press **Enter** to send the command.

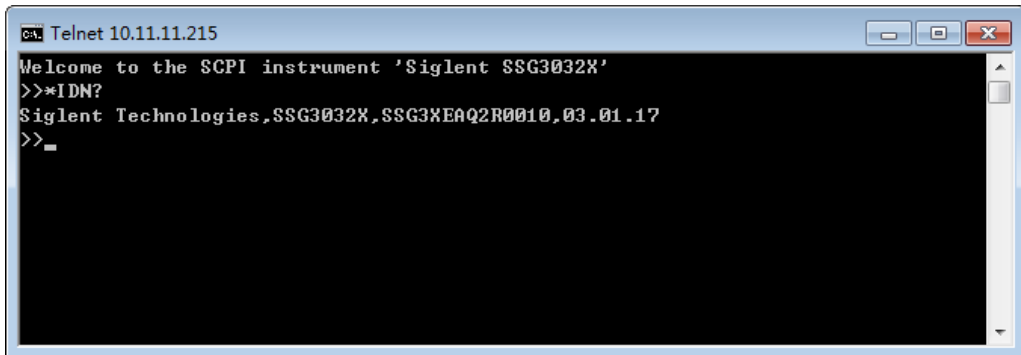

```
ca. Telnet 10.11.11.215
Welcome to the SCPI instrument 'Siglent SSG3032X'
>>*IDN?
Siglent Technologies,SSG3032X,SSG3XEAQ2R0010,03.01.17
>>_
```

- To exit the telnet window click **X** in the upper-right corner.
- To get a normal telnet prompt, press **Ctrl+]** (closing bracket).

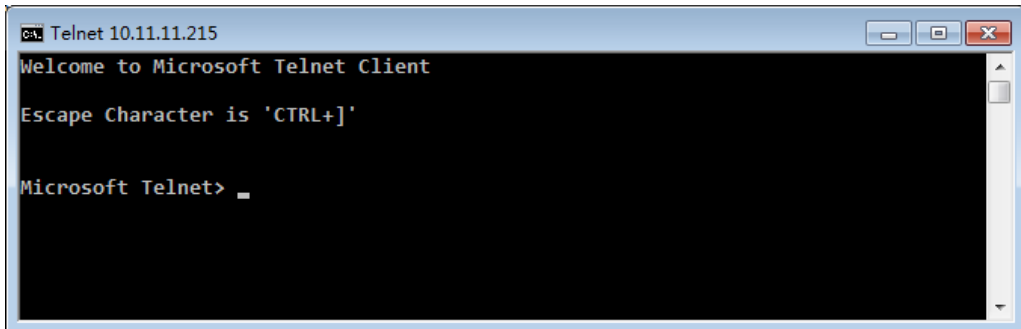

```
ca. Telnet 10.11.11.215
Welcome to Microsoft Telnet Client
Escape Character is 'CTRL+ ]'
Microsoft Telnet> _
```

- To get SCPI prompt again, type **open <ip Address> 5024**.

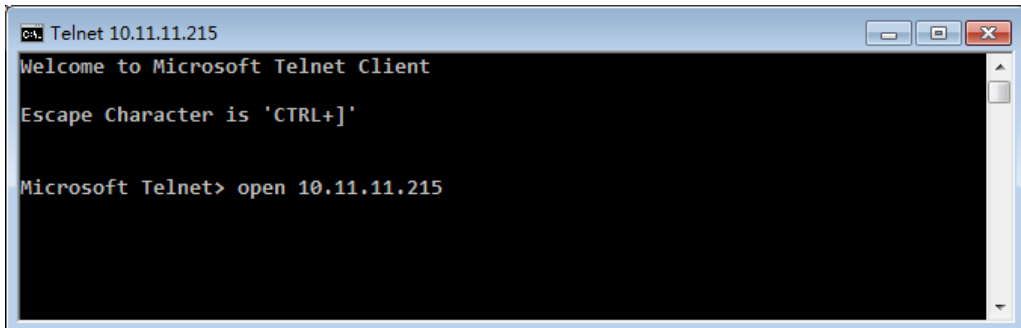

```
ca. Telnet 10.11.11.215
Welcome to Microsoft Telnet Client
Escape Character is 'CTRL+ ]'
Microsoft Telnet> open 10.11.11.215
```

- Press **Enter**

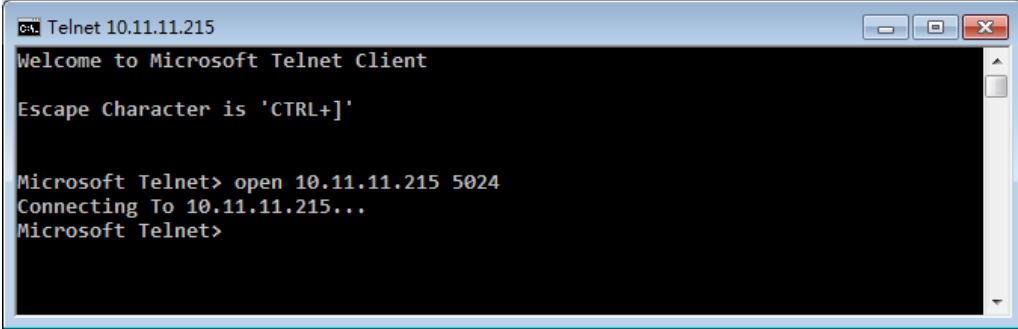

```
ca. Telnet 10.11.11.215
Welcome to Microsoft Telnet Client
Escape Character is 'CTRL+]'

Microsoft Telnet> open 10.11.11.215 5024
Connecting To 10.11.11.215...
Microsoft Telnet>
```

- To close the normal telnet window, type **Quit** and press **Enter**.

About SIGLENT

SIGLENT is an international high-tech company, concentrating on R&D, sales, production and services of electronic test & measurement instruments.

SIGLENT first began developing digital oscilloscopes independently in 2002. After more than a decade of continuous development, SIGLENT has extended its product line to include digital oscilloscopes, isolated handheld oscilloscopes, function/arbitrary waveform generators, RF/MW signal generators, spectrum analyzers, vector network analyzers, digital multimeters, DC power supplies, electronic loads and other general purpose test instrumentation. Since its first oscilloscope was launched in 2005, SIGLENT has become the fastest growing manufacturer of digital oscilloscopes. We firmly believe that today SIGLENT is the best value in electronic test & measurement.

Headquarters:

SIGLENT Technologies Co., Ltd
Add: Bldg No.4 & No.5, Antongda Industrial
Zone, 3rd Liuxian Road, Bao'an District,
Shenzhen, 518101, China
Tel: + 86 755 3688 7876
Fax: + 86 755 3359 1582
Email: sales@siglent.com
Website: int.siglent.com

USA:

SIGLENT Technologies America, Inc
6557 Cochran Rd Solon, Ohio 44139
Tel: 440-398-5800
Toll Free: 877-515-5551
Fax: 440-399-1211
Email: info@siglent.com
Website: www.siglentna.com

Europe:

SIGLENT Technologies Germany GmbH
Add: Staetzlinger Str. 70
86165 Augsburg, Germany
Tel: +49(0)-821-666 0 111 0
Fax: +49(0)-821-666 0 111 22
Email: info-eu@siglent.com
Website: www.siglenteu.com

Follow us on
Facebook: SiglentTech

